

Chicka Chicka Boom Boom Lapbook

Assembling Your Lapbook

You will need two file folders to create this tri-fold lapbook. Add the cover page to the front. Place the first letter alphabet matching game in the file folder. The Chicka Chicka Boom Boom book goes in the center. Place the coconut number puzzles in the file folder.

Front Cover

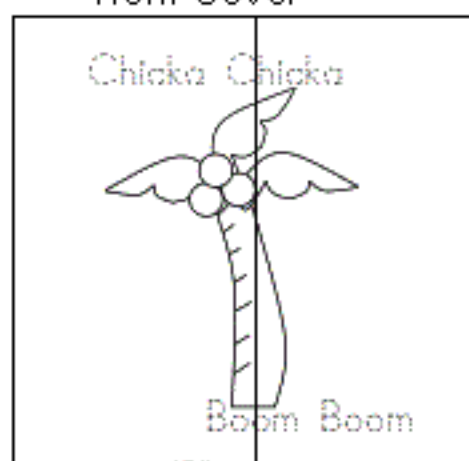

Inside

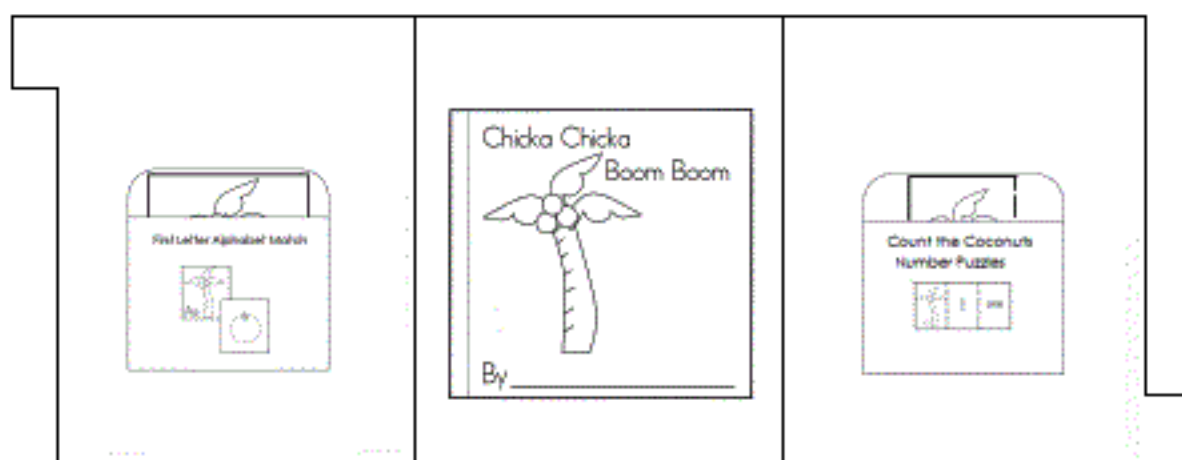

Created by Ruth

<http://www.archjrc.com/childsplace/>

Igbo clipart courtesy of FunDraw Public Domain - <http://www.fundraw.com/>

Xylophone, violin, and yo-yo clipart courtesy of Microsoft Clipart Gallery -

<http://office.microsoft.com/en-ca/clipart/default.aspx?cag=1>

All other clipart drawn by Ruth and Chantelle - <http://www.archjrc.com/clipart/>

Chicka Chicka

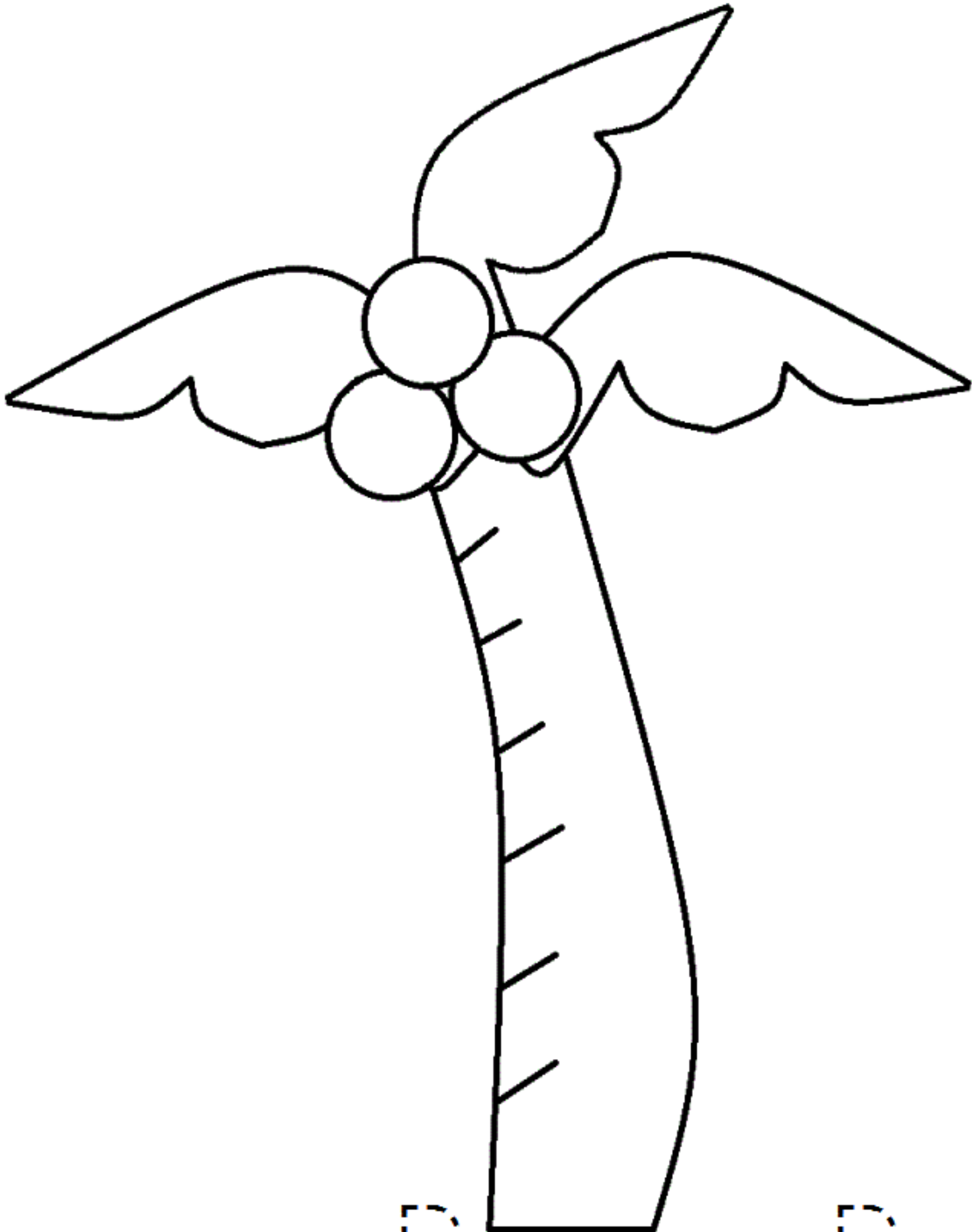

Boom Boom

First Letter Alphabet Match

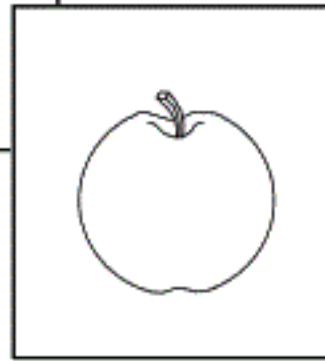
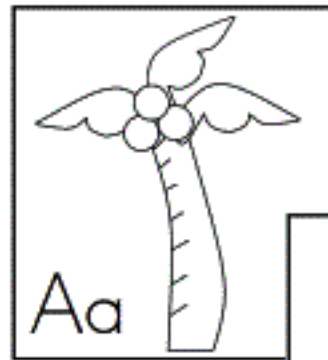

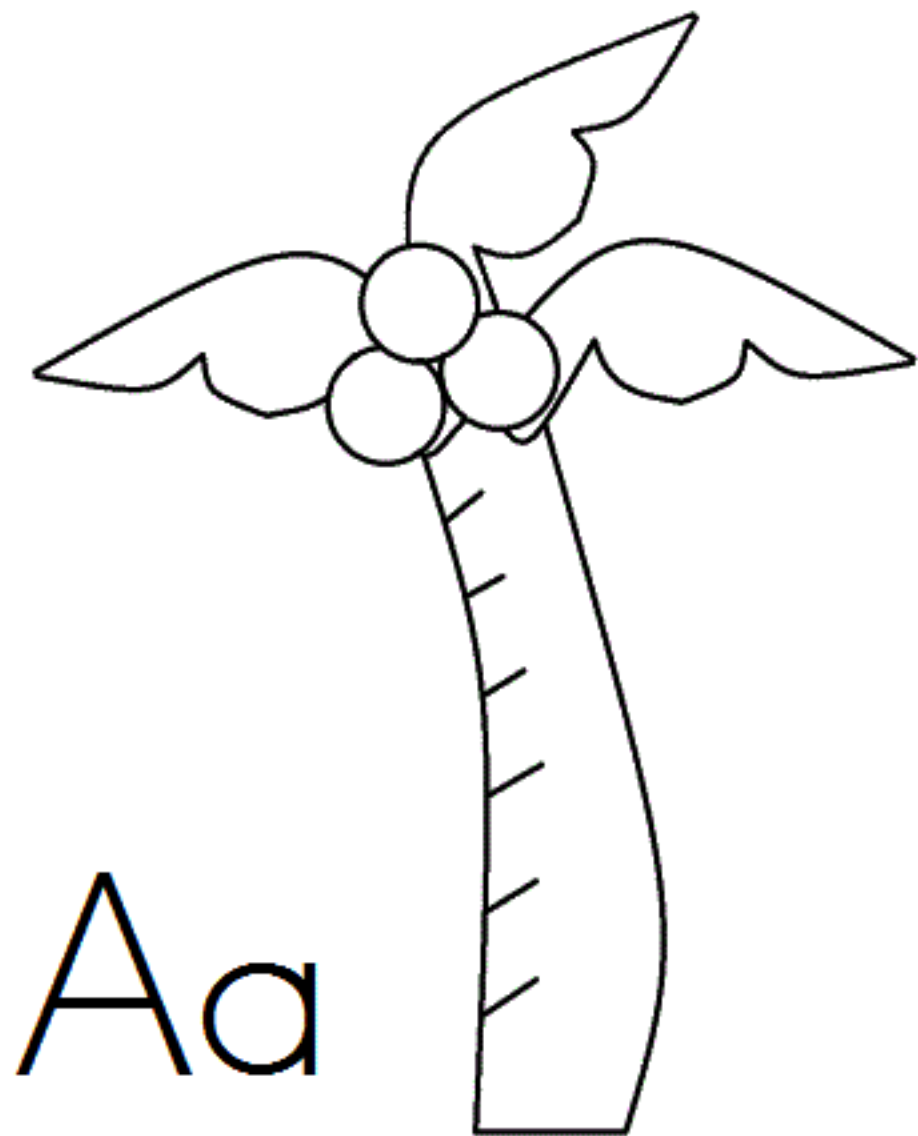

Aa

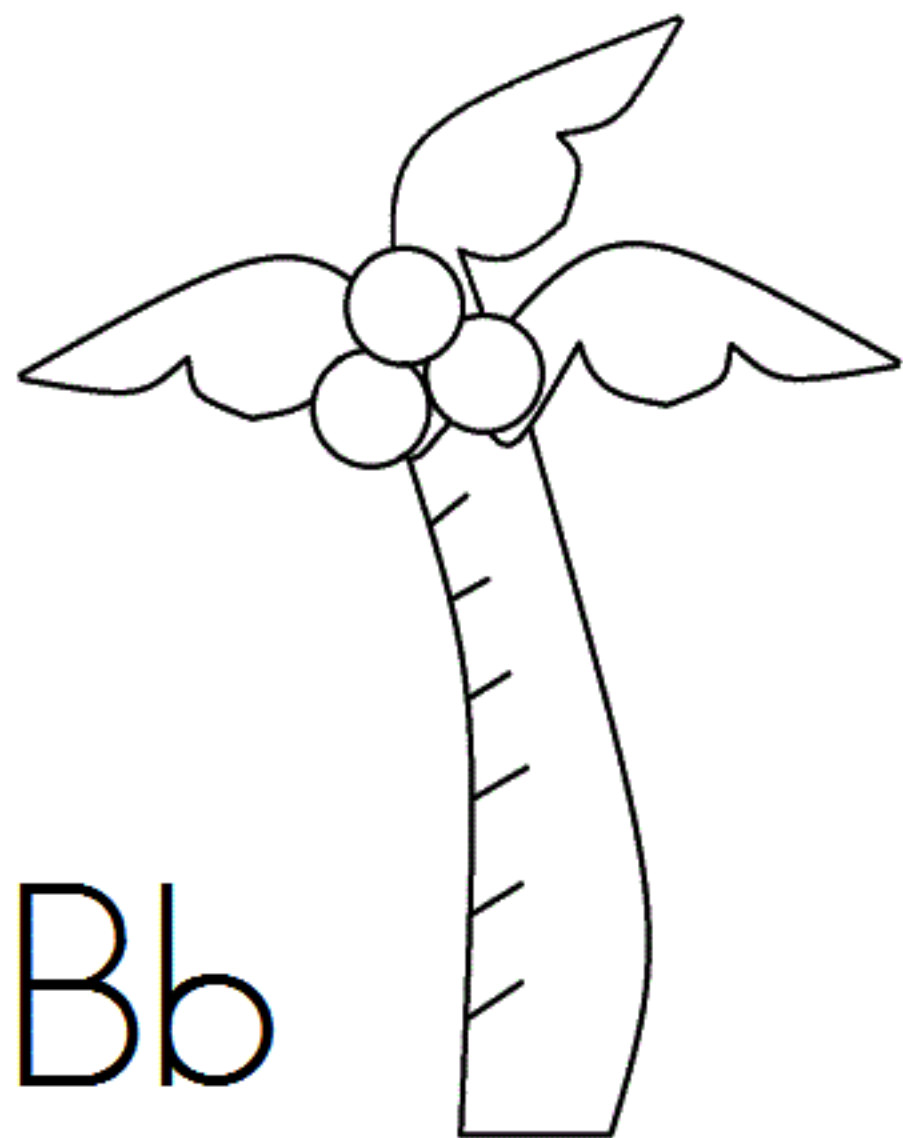
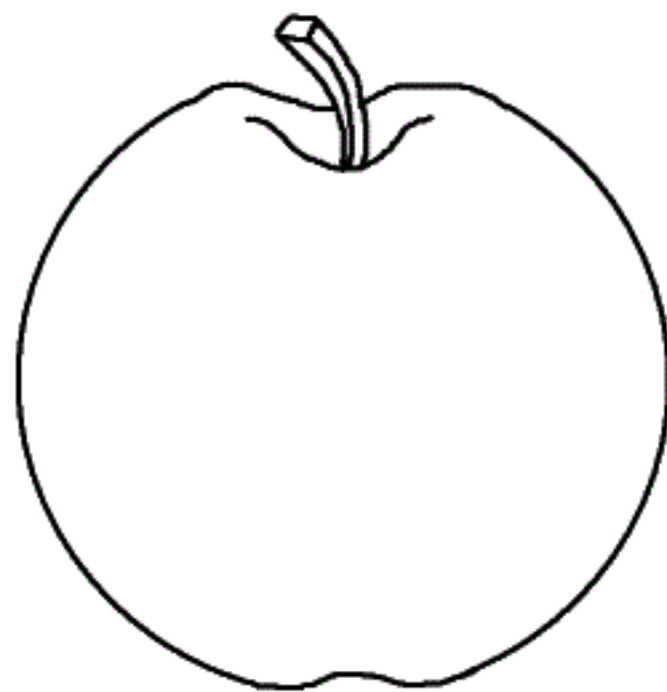

Bb

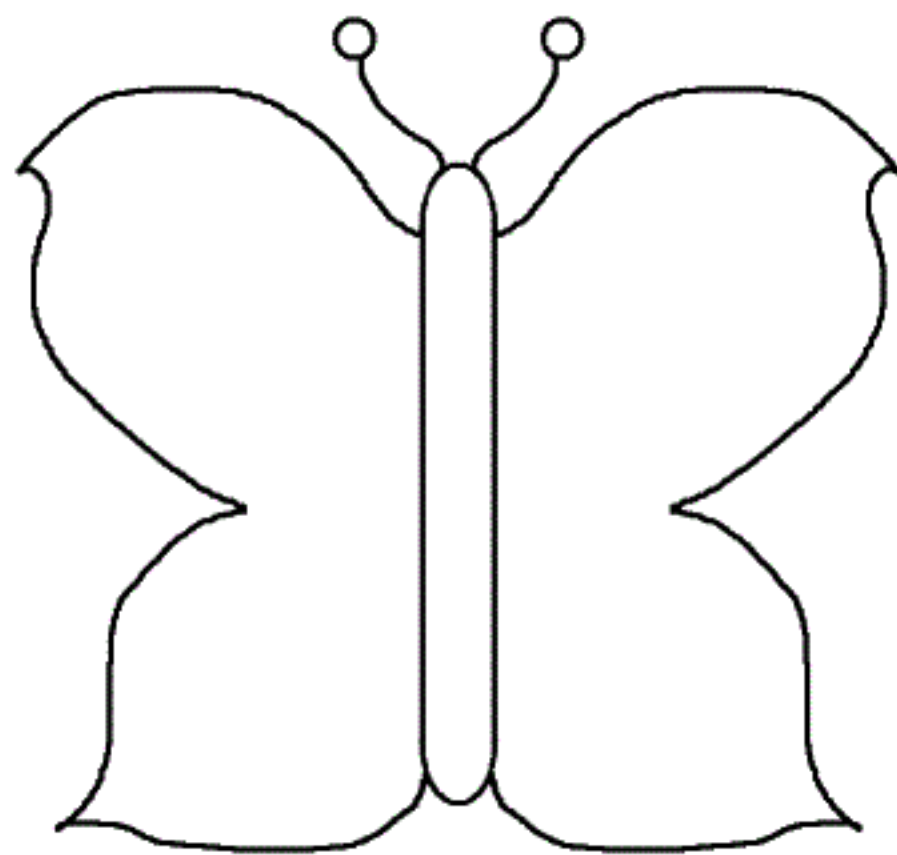

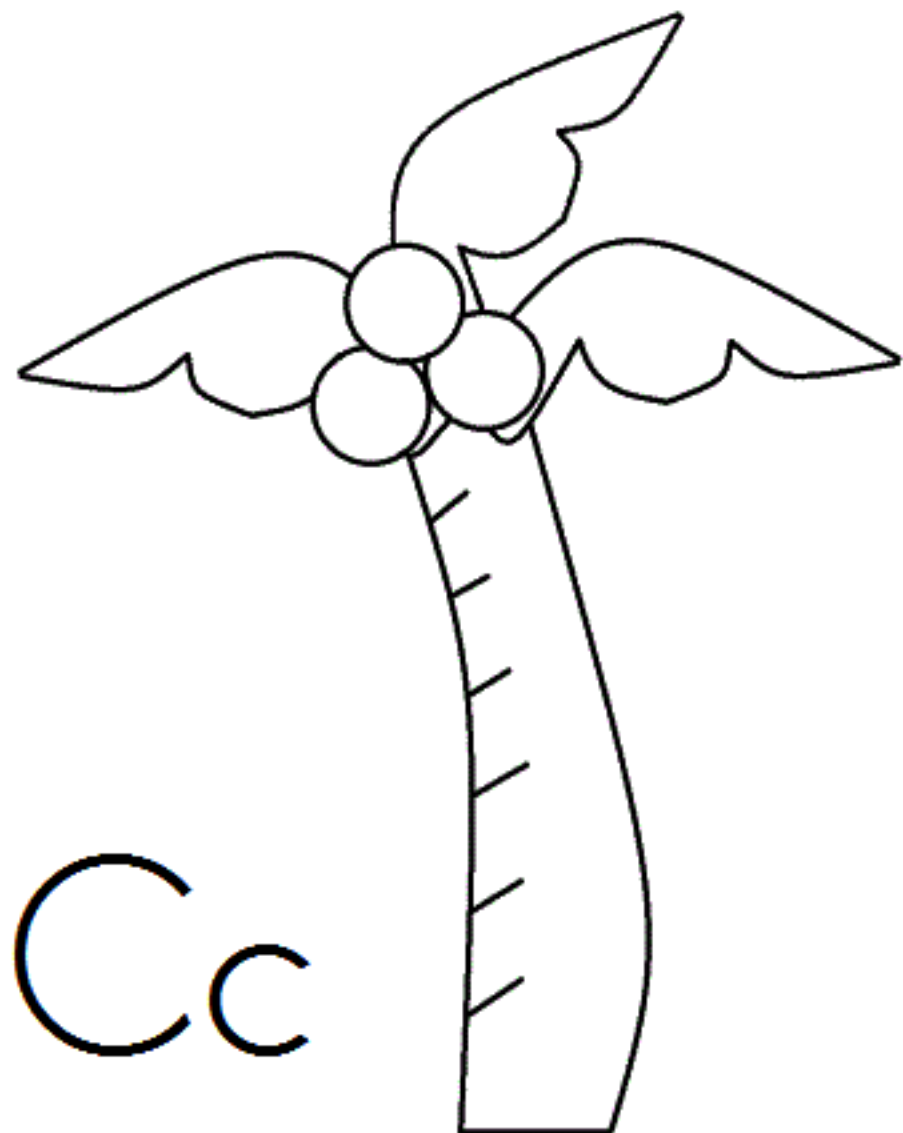

Cc

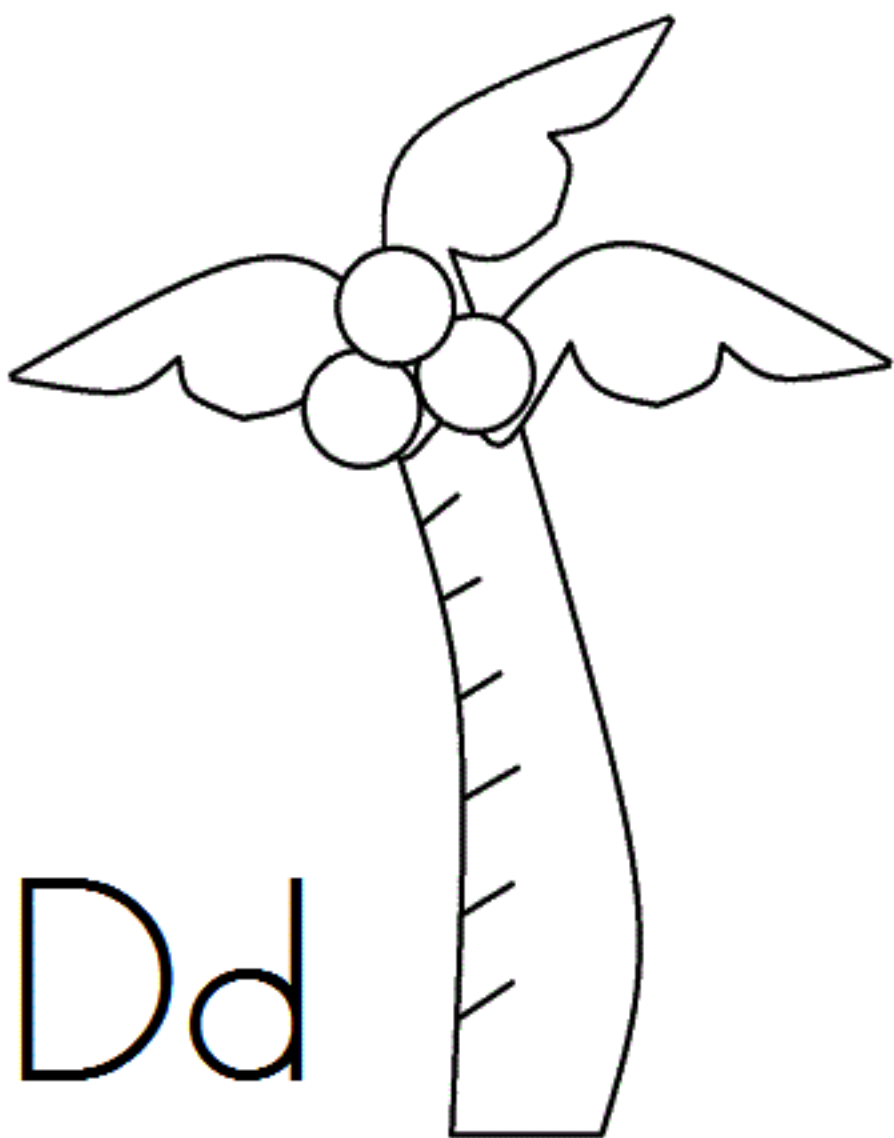
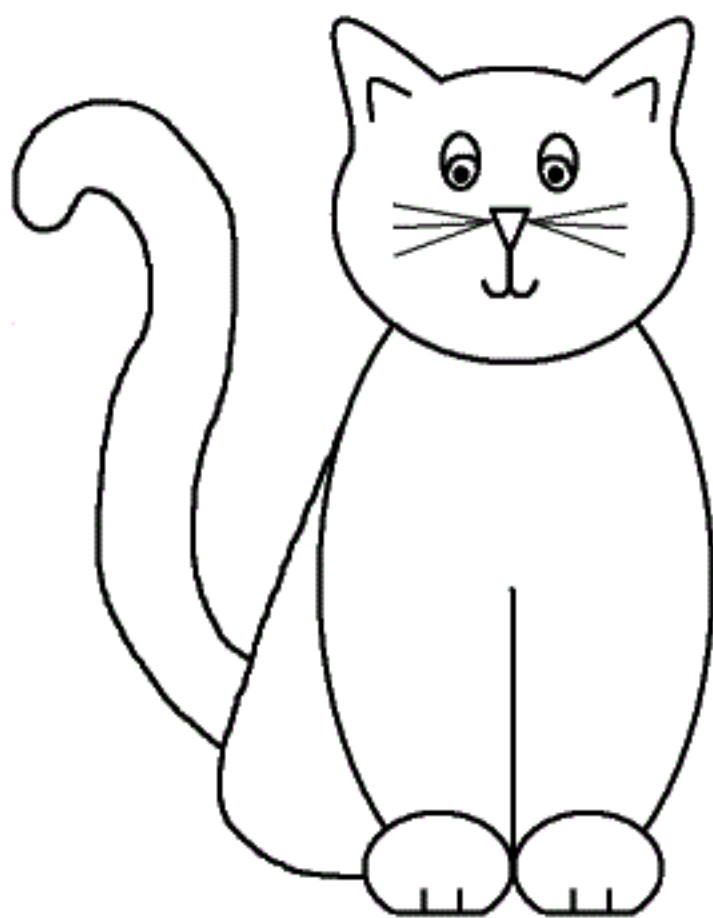

Dd

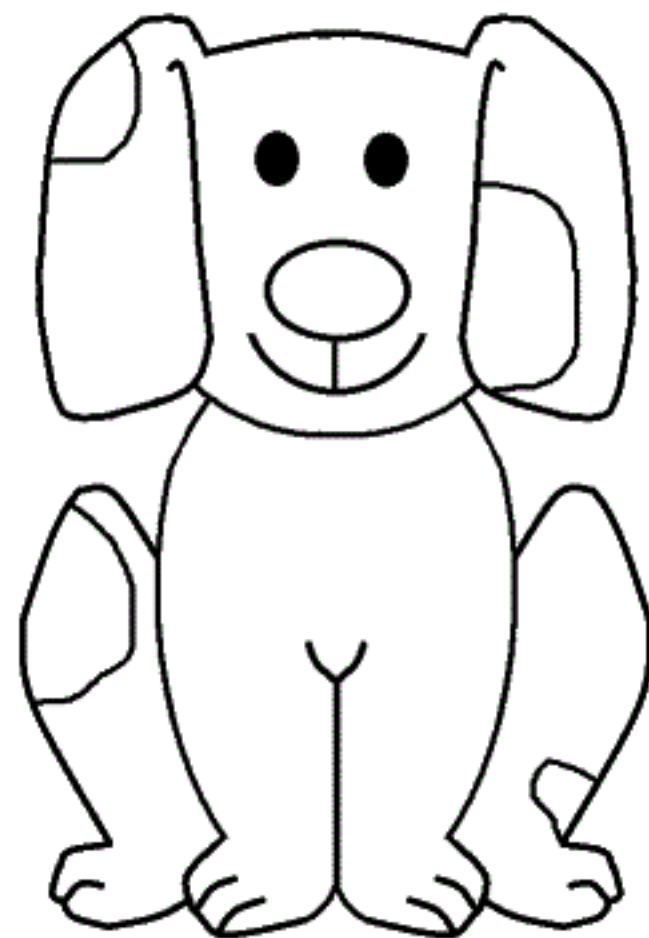

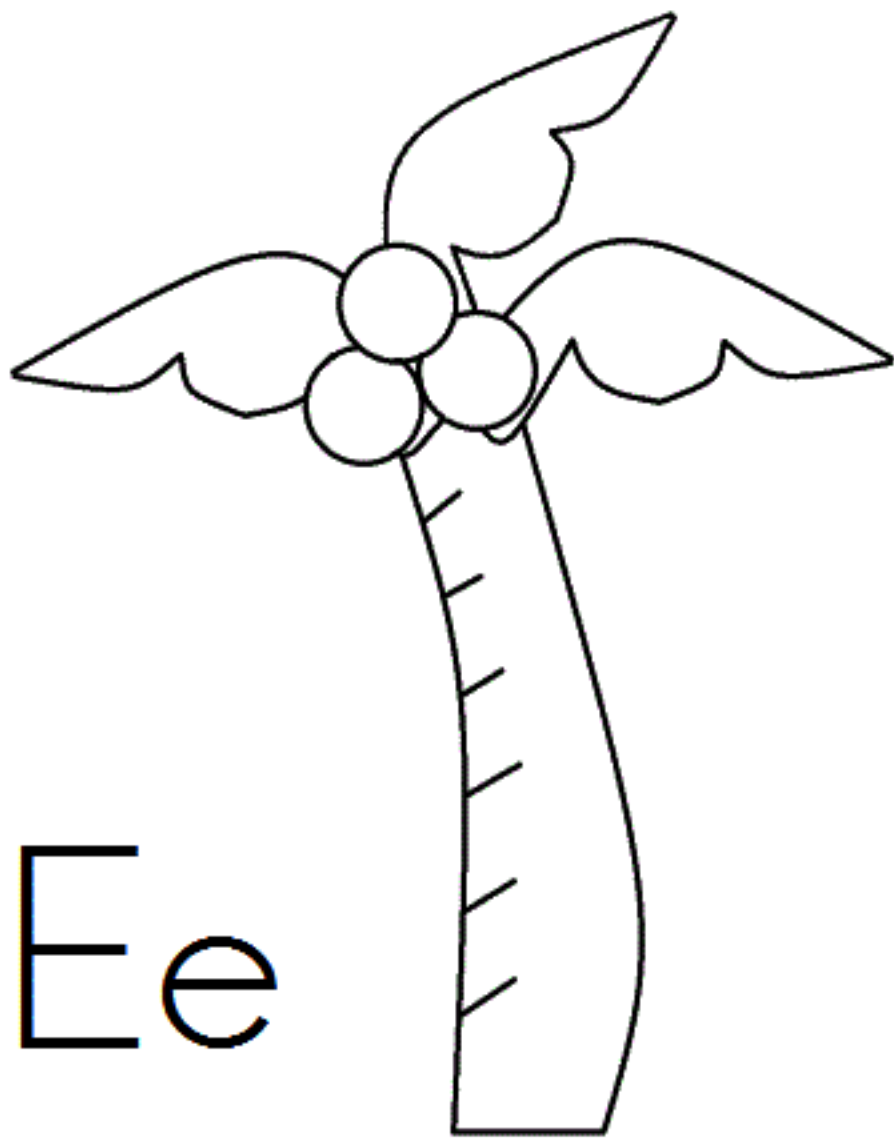

E e

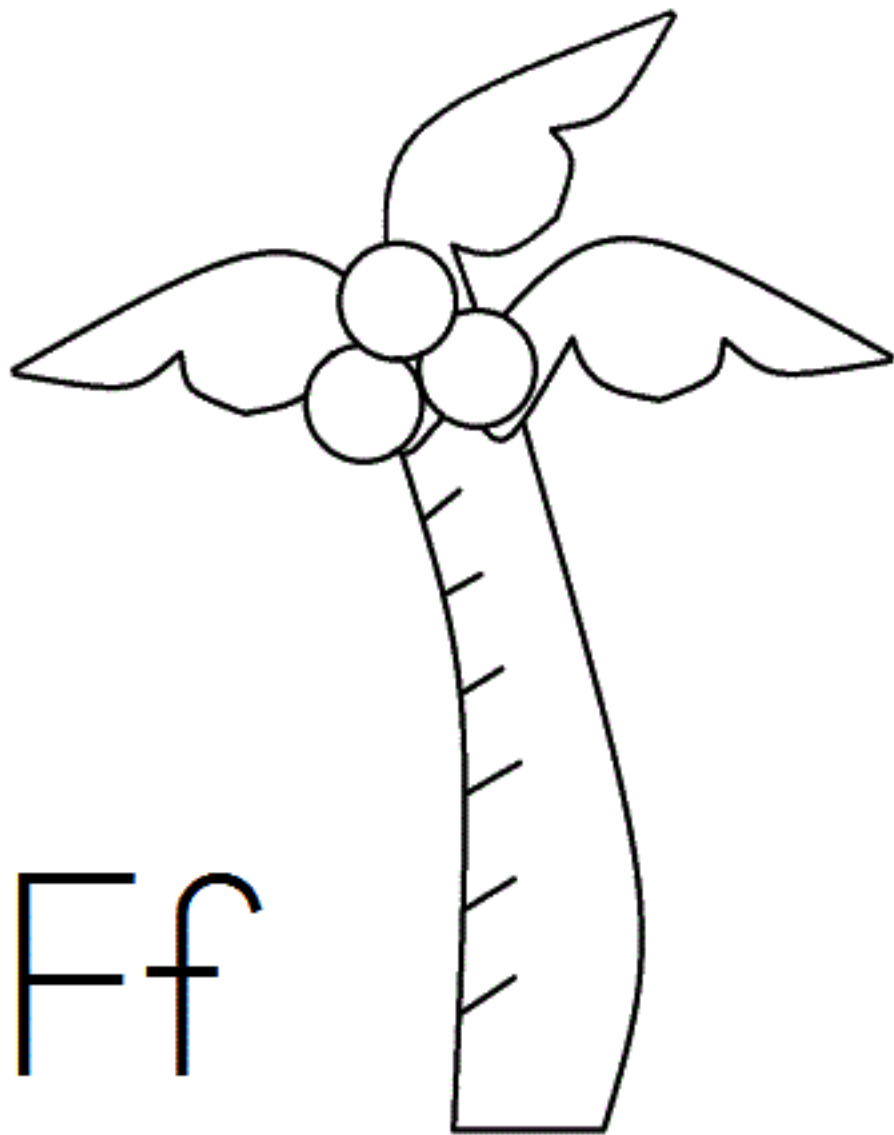
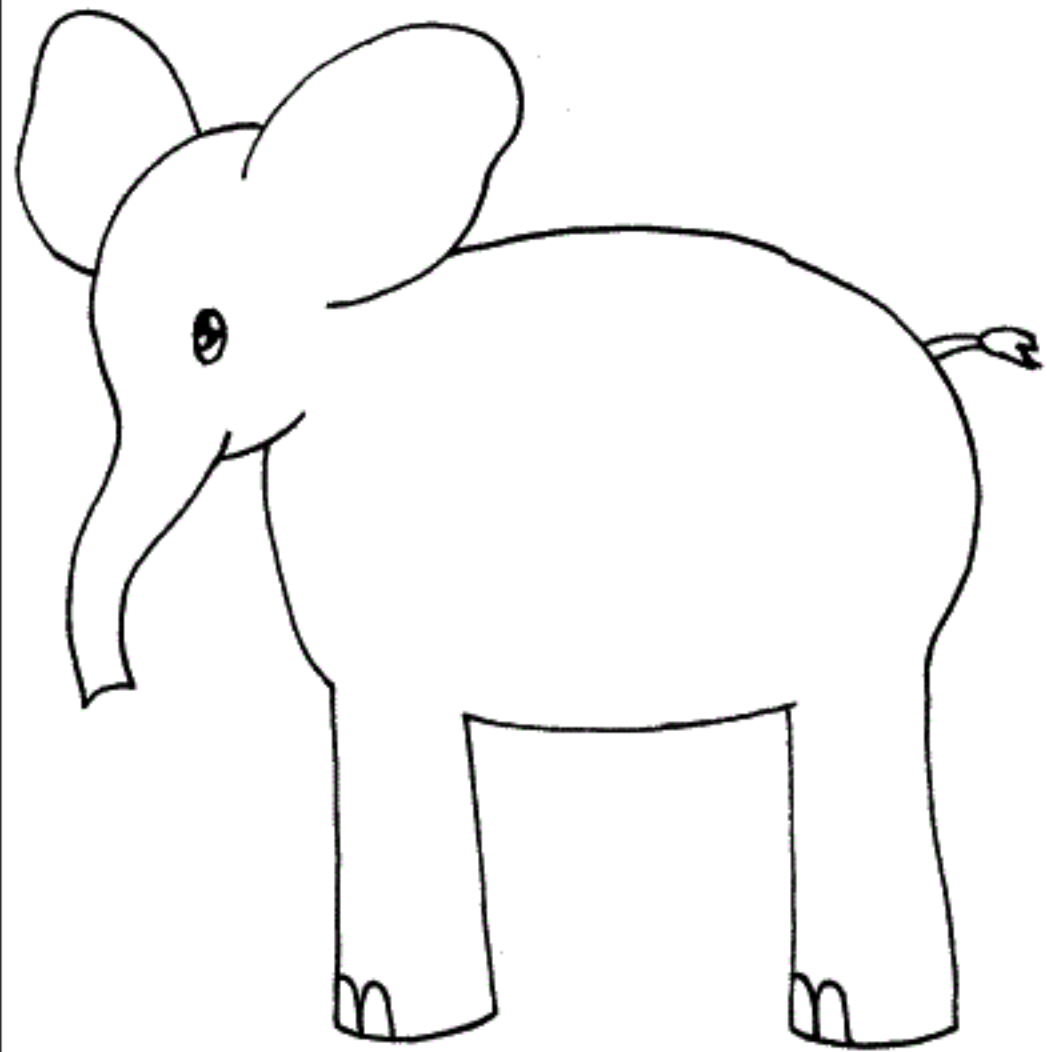

F f



Gg

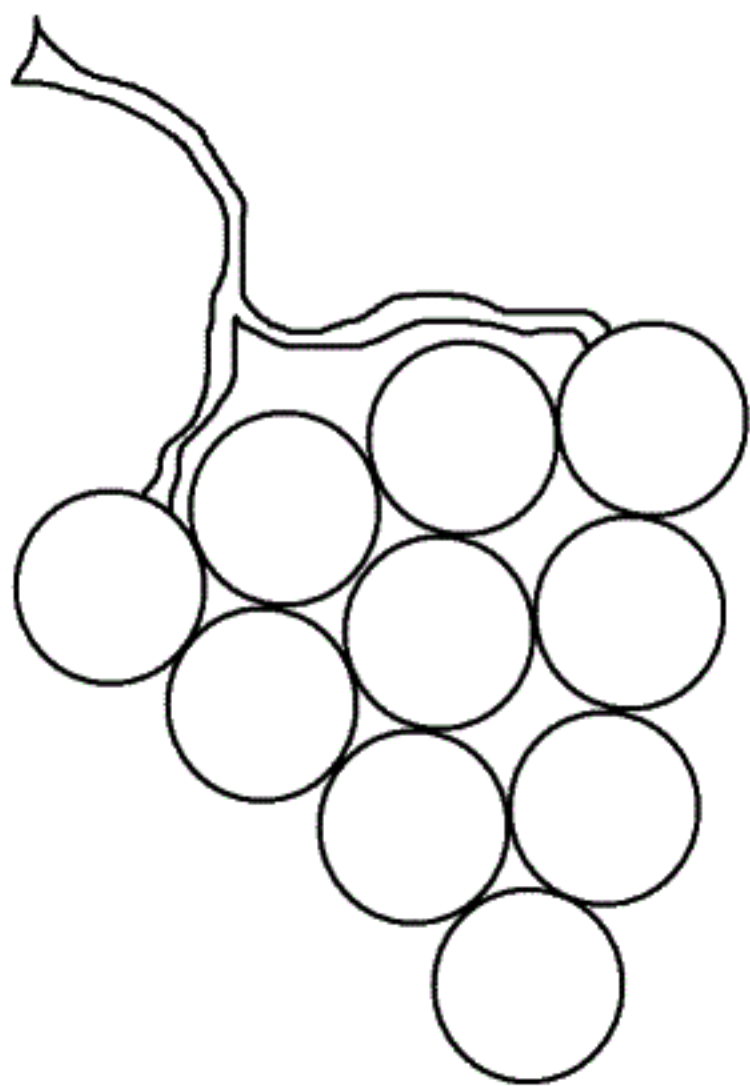
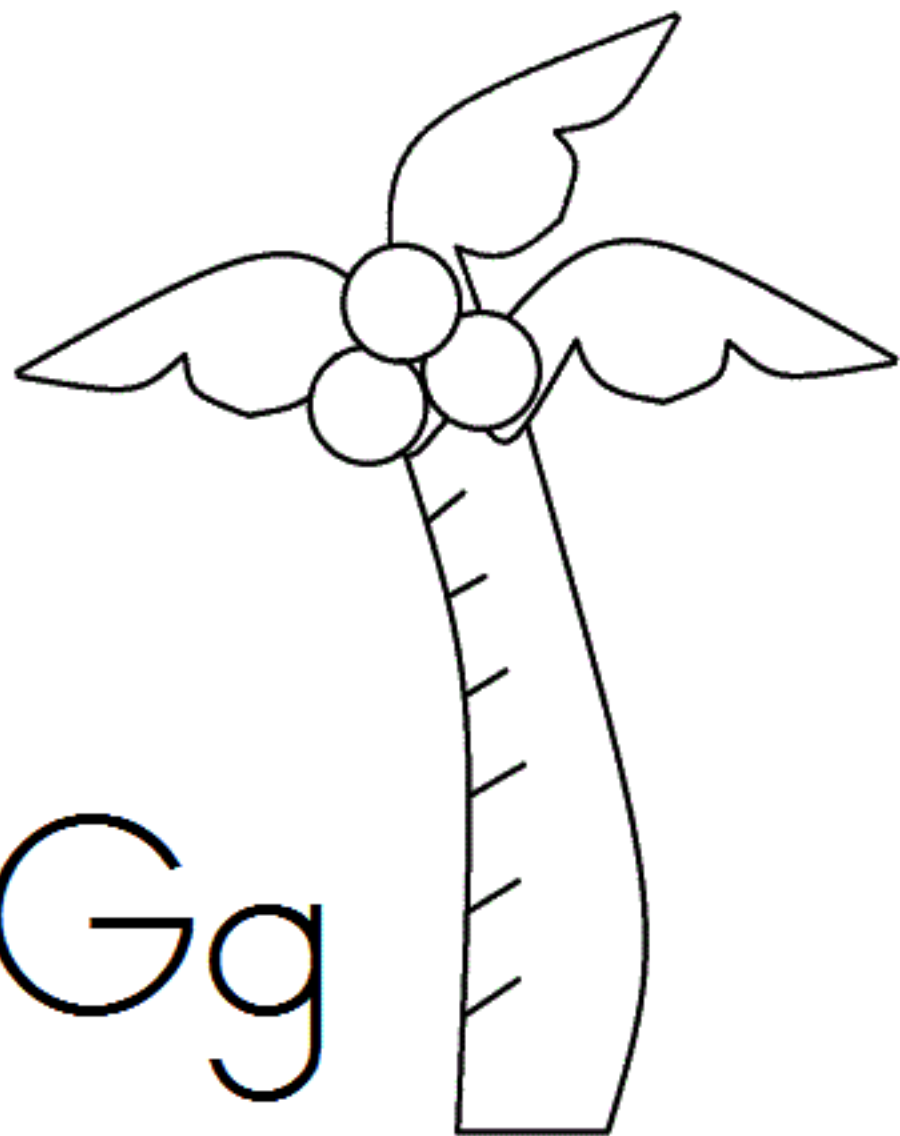

Hh

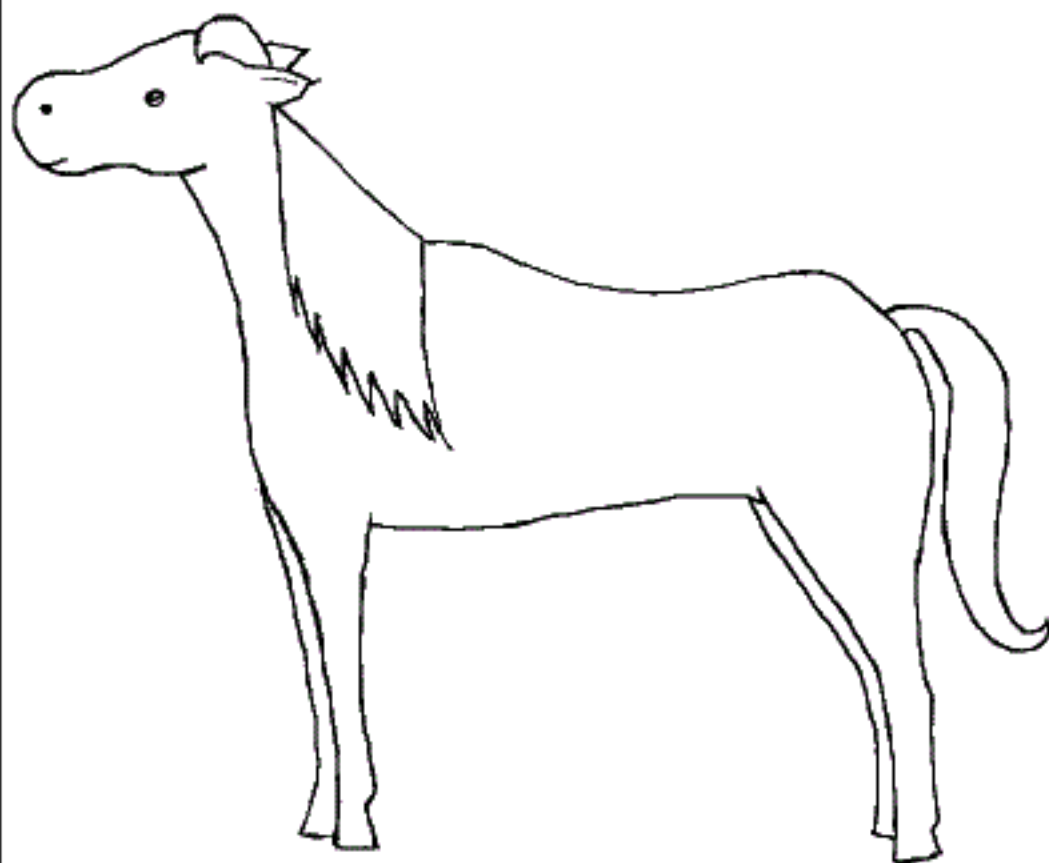
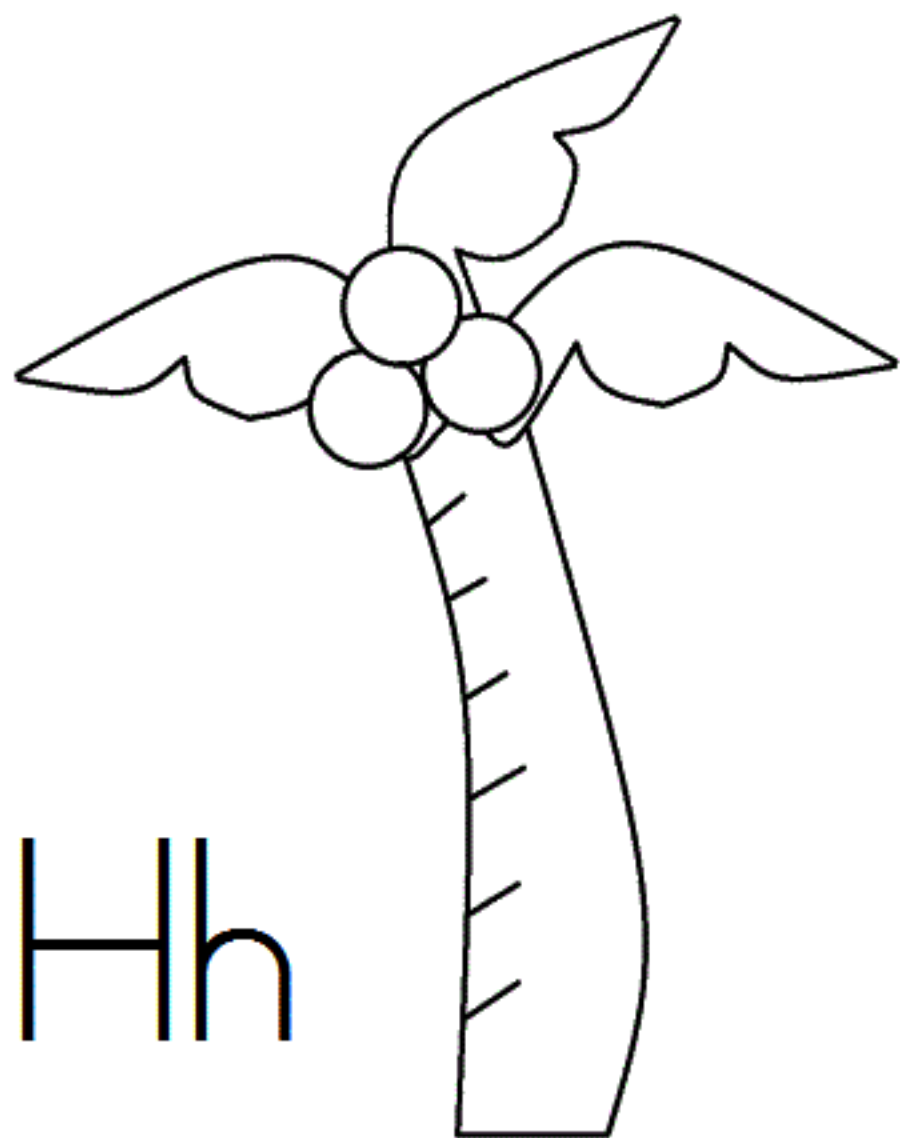

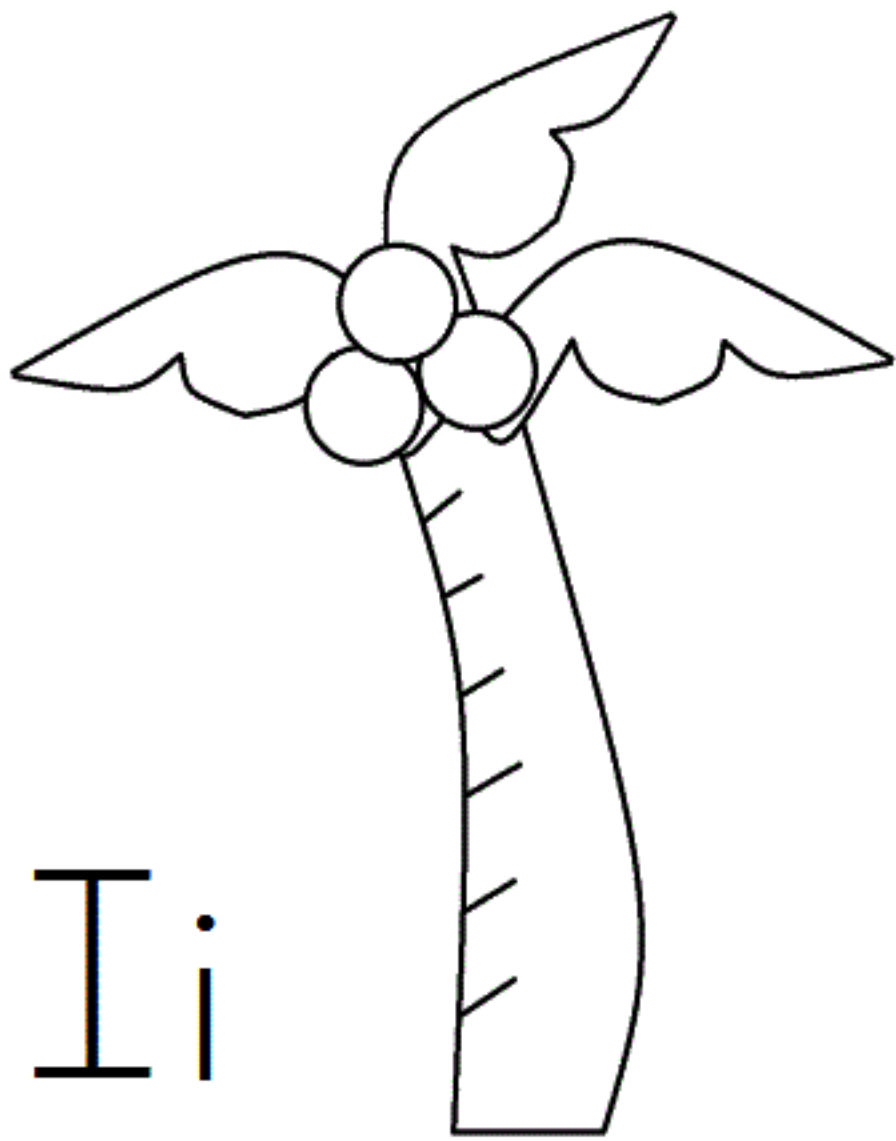

Ii

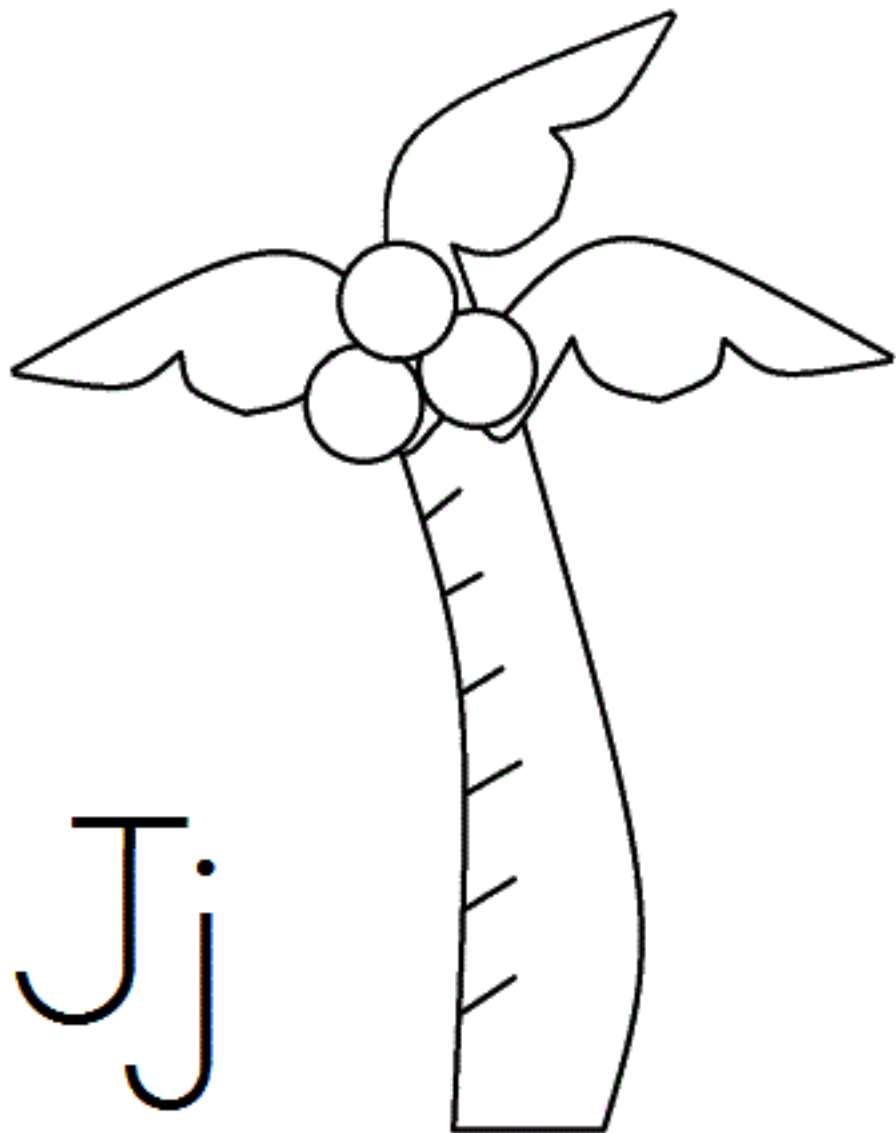

Jj

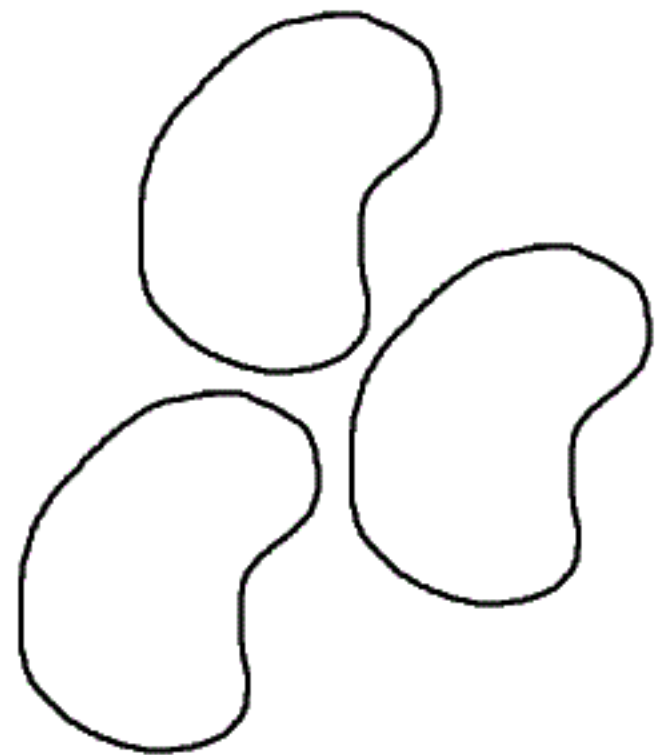

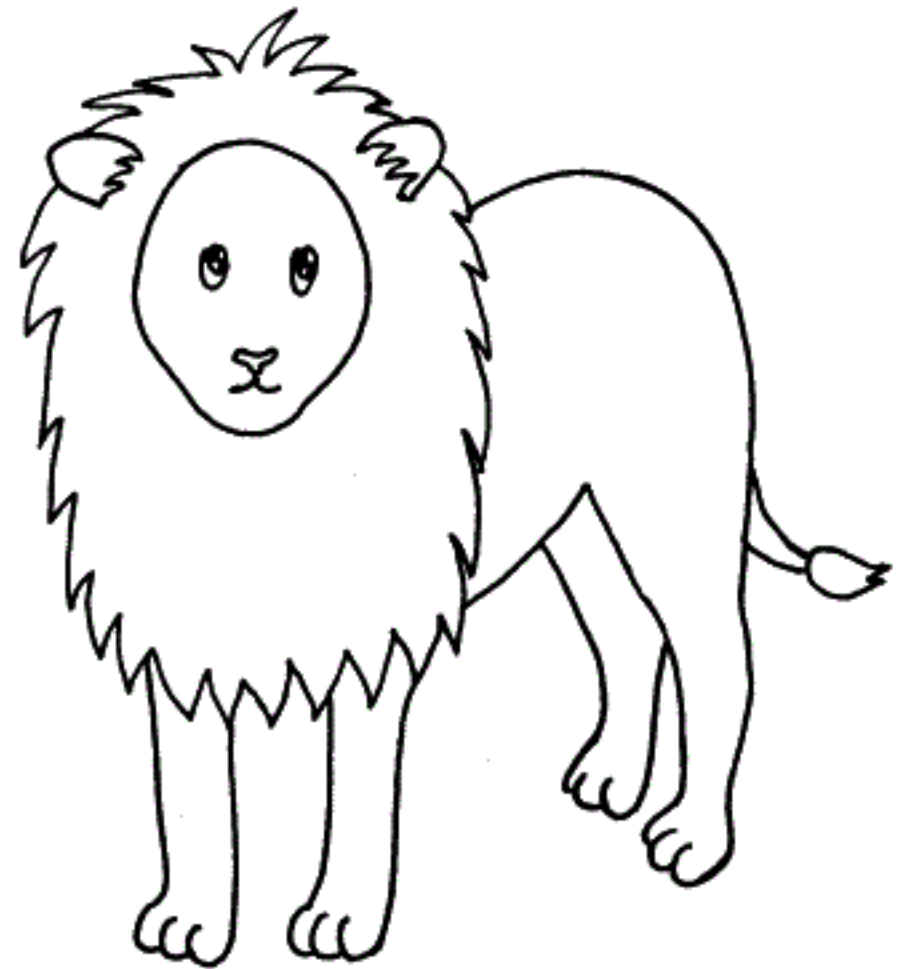
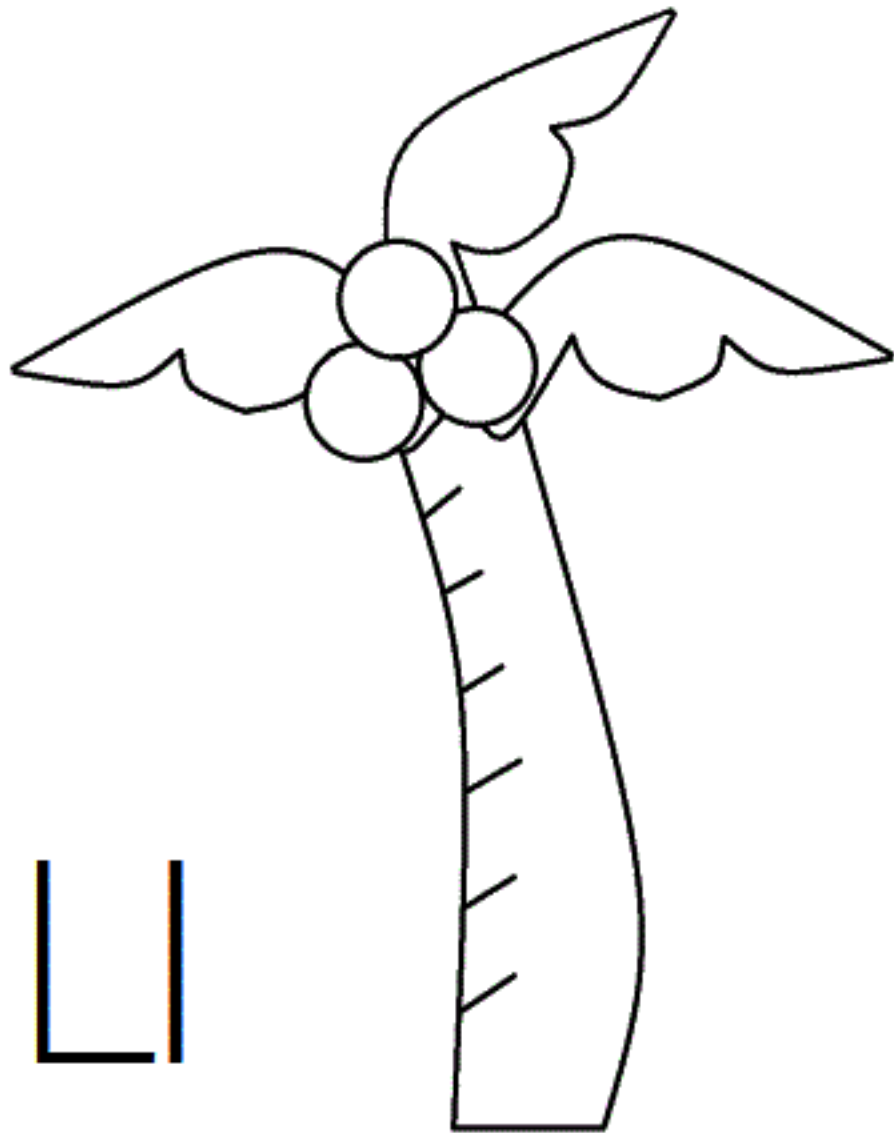
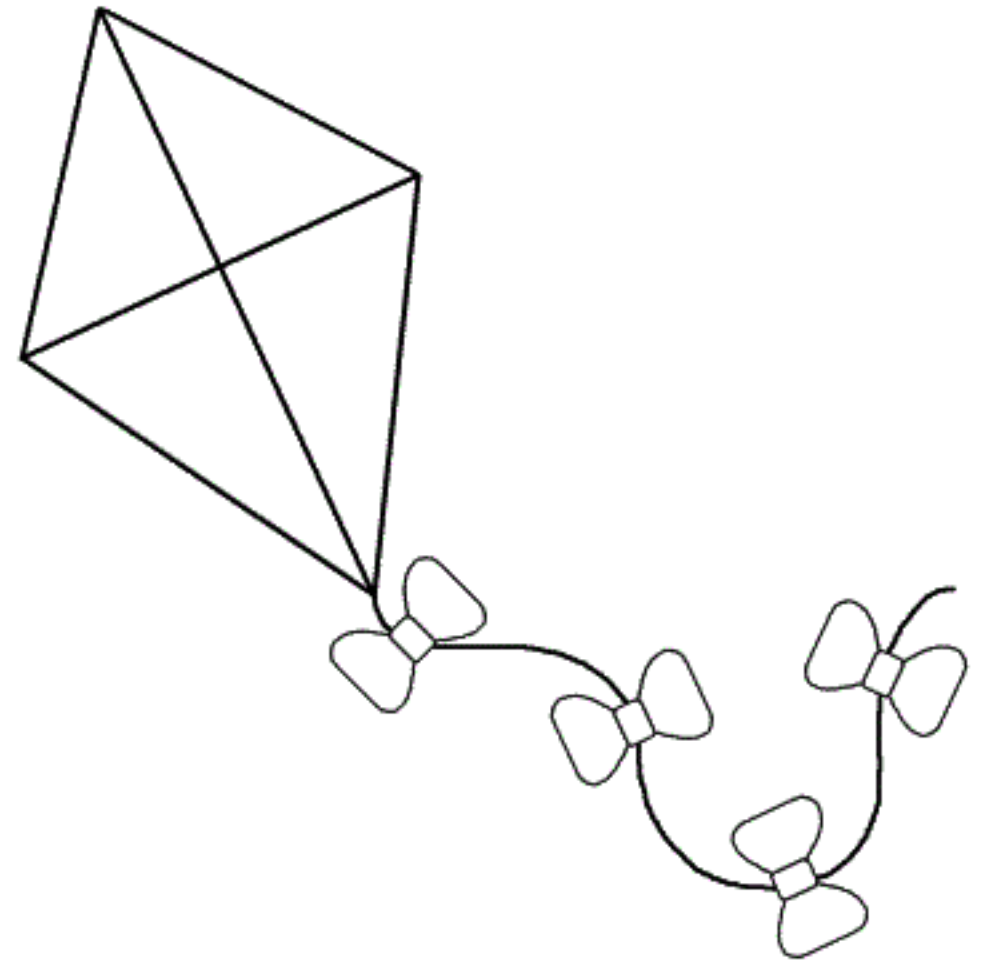
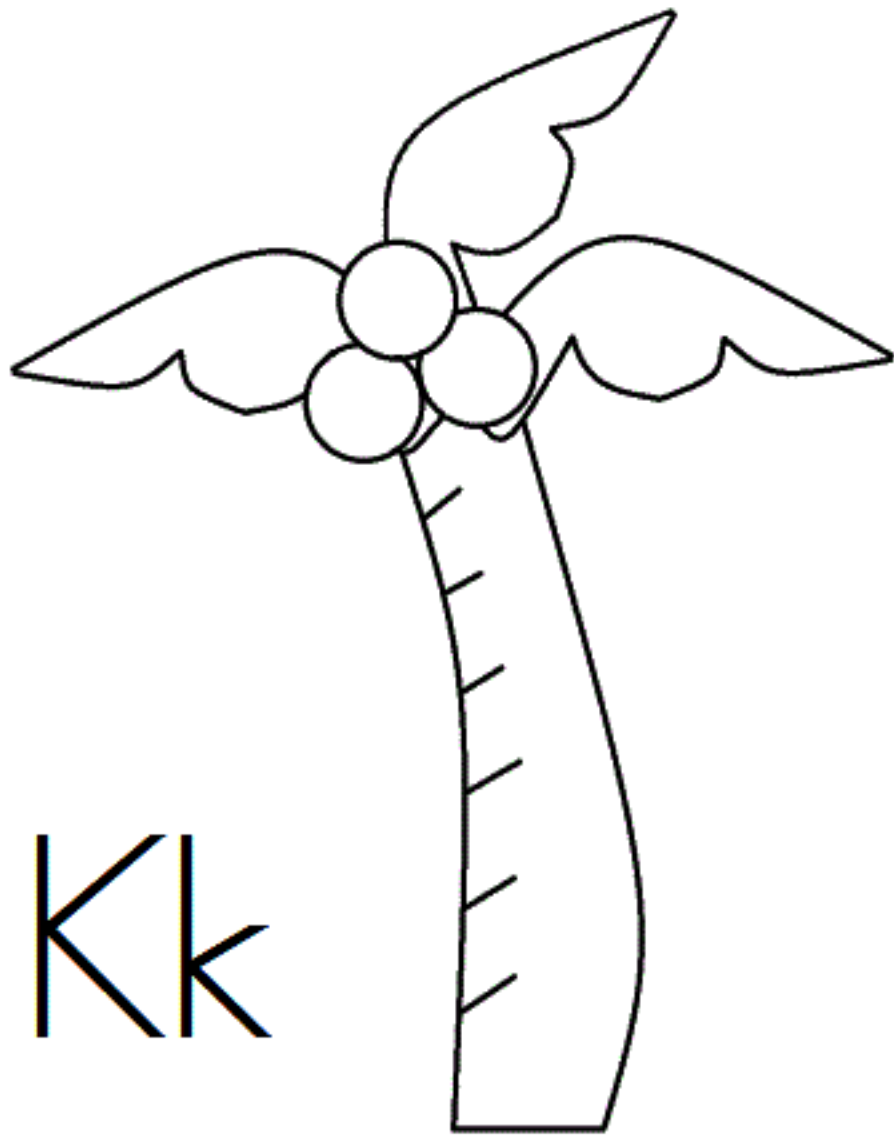

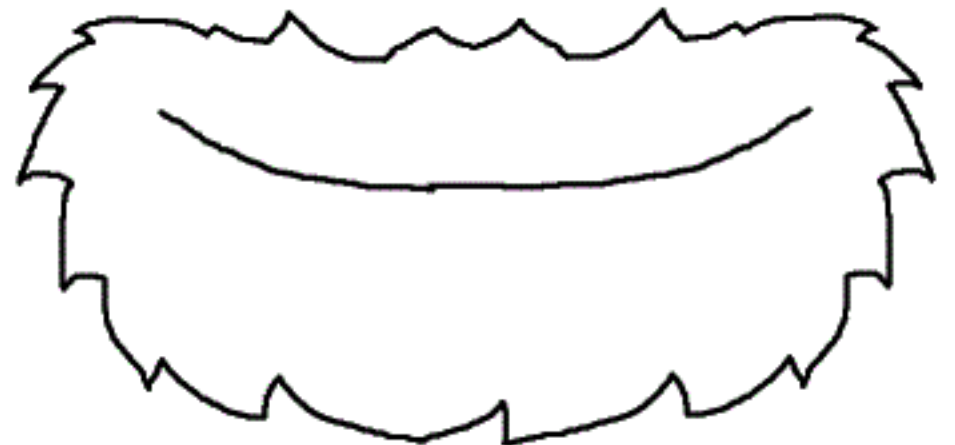
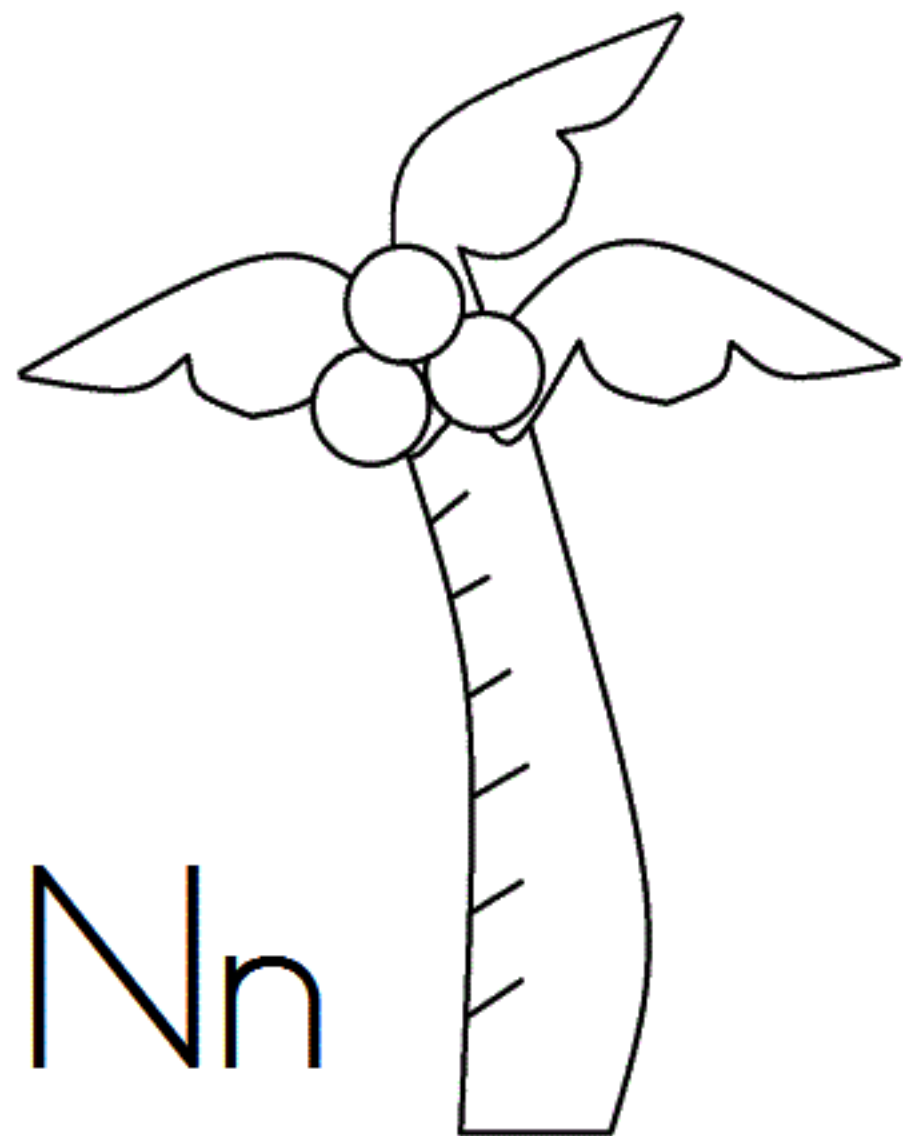
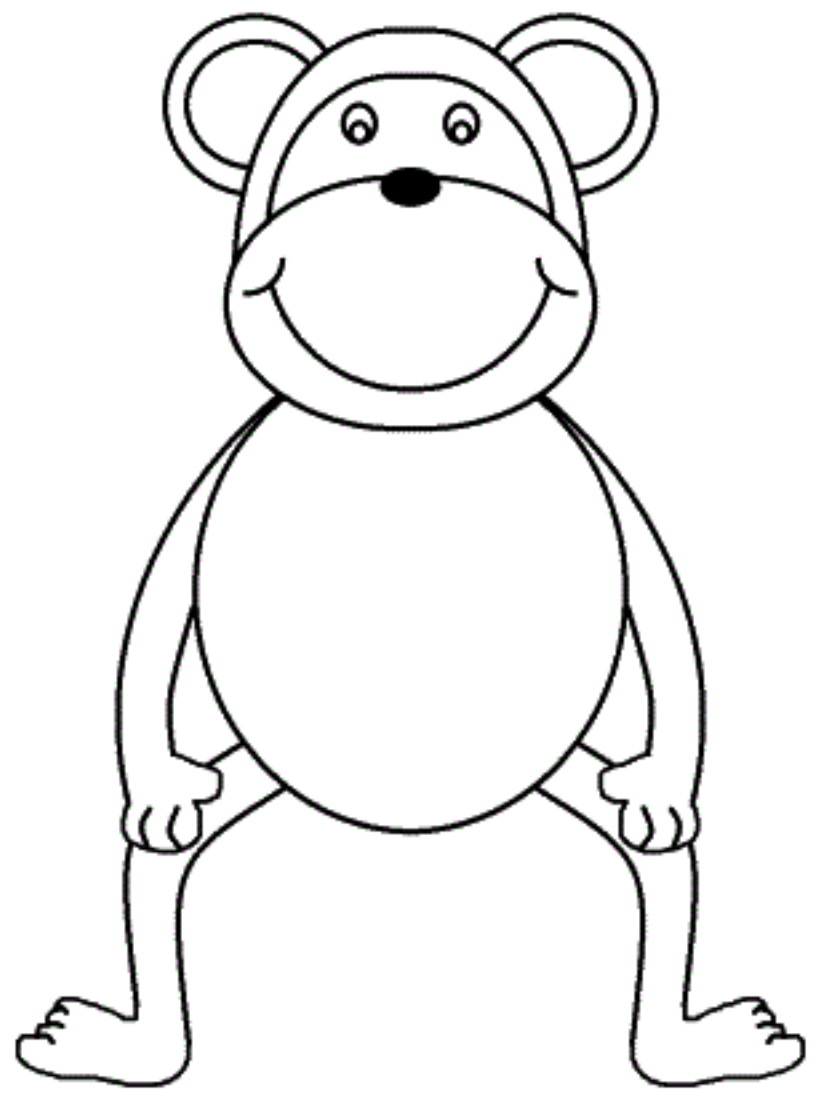
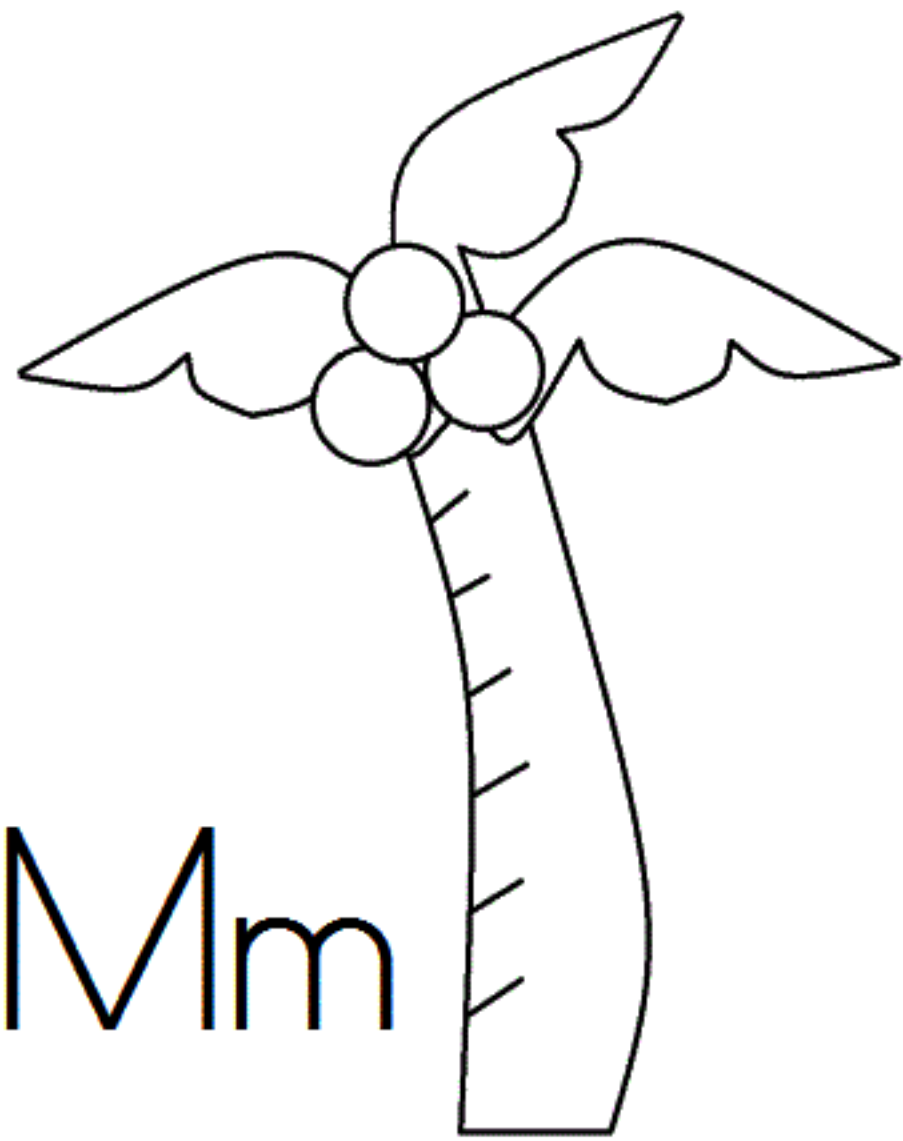

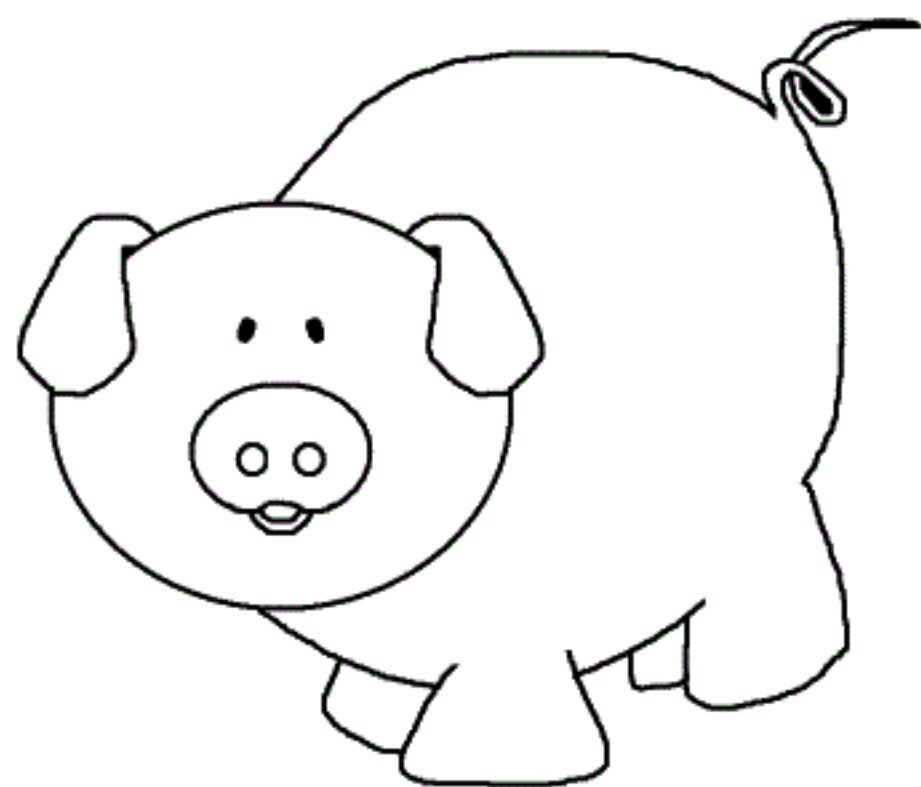
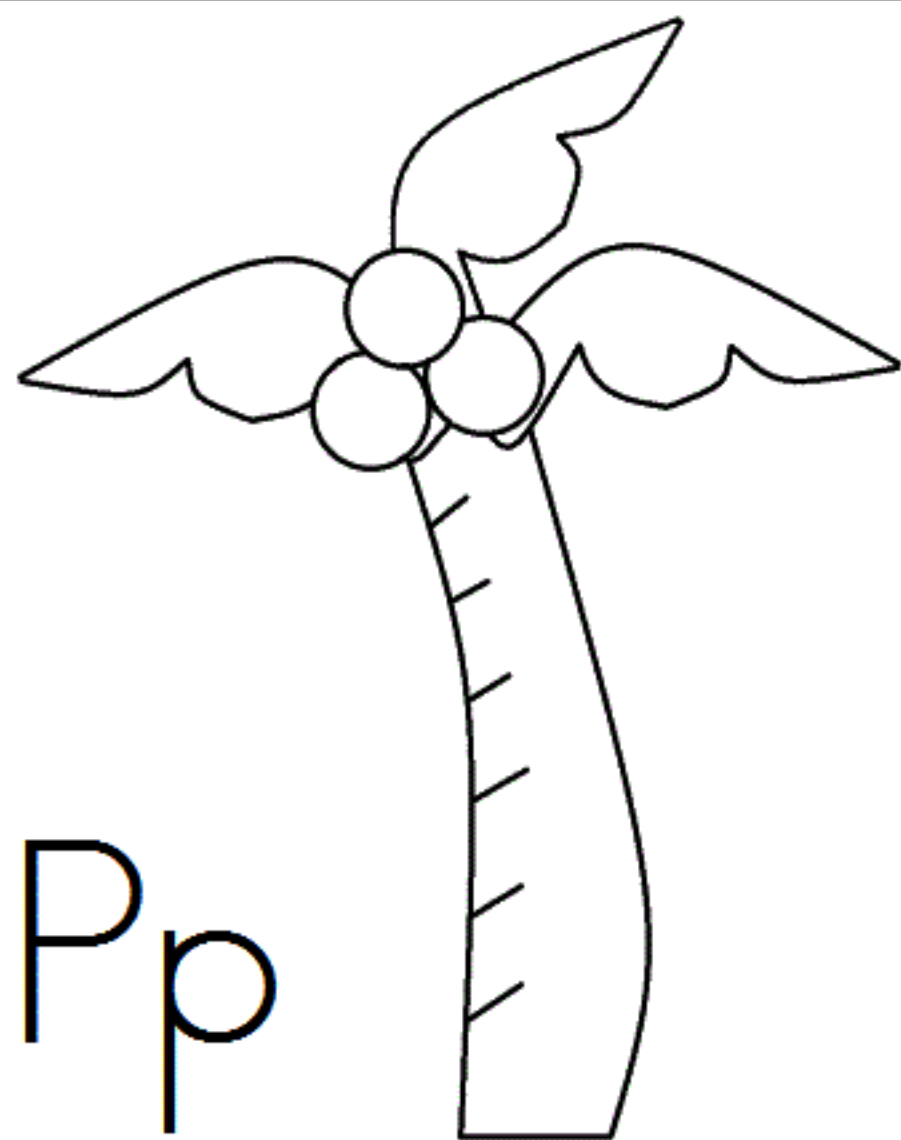
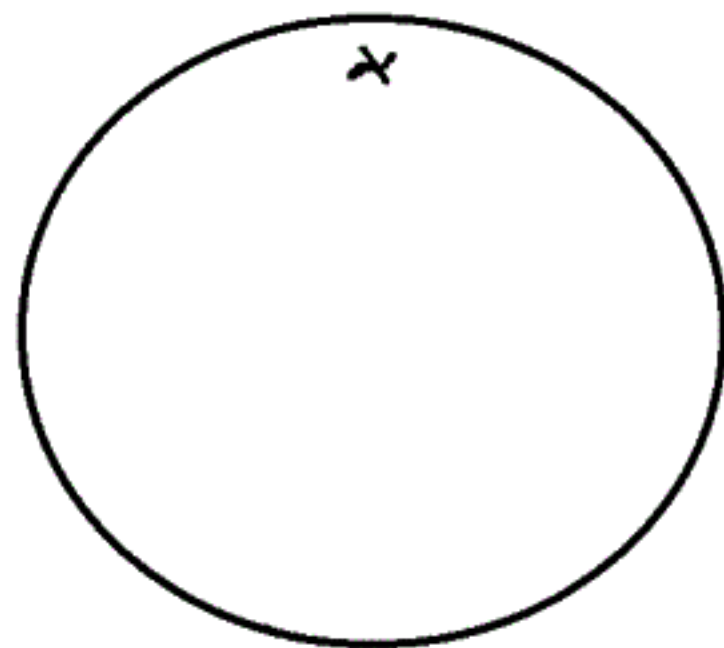
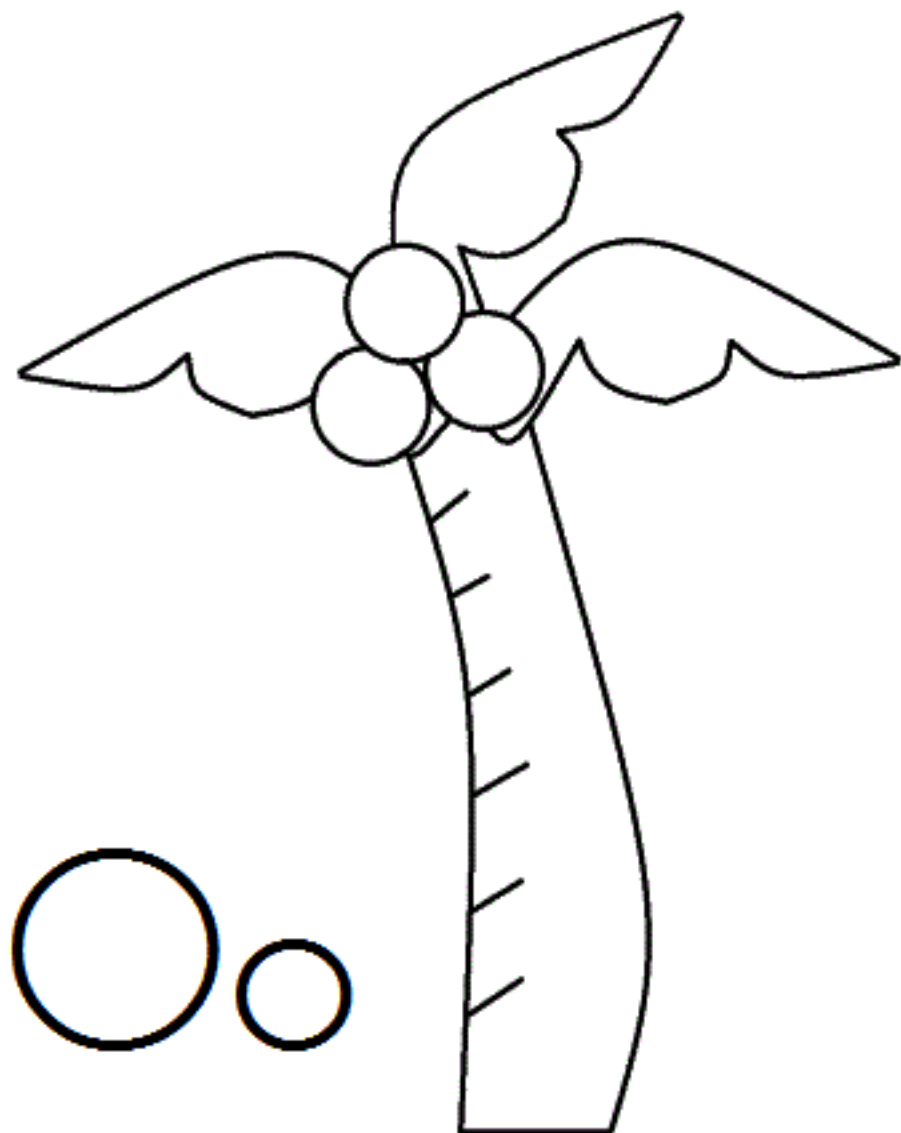

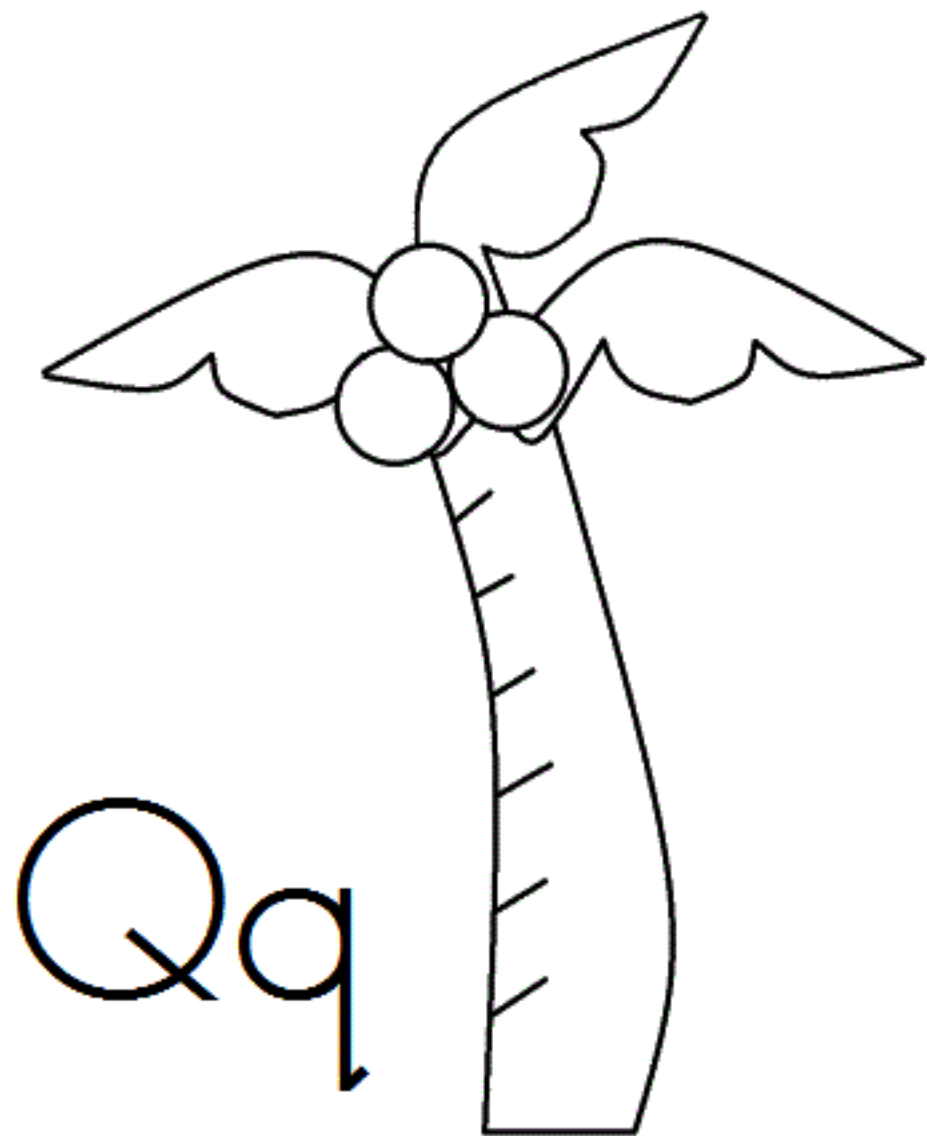

Qq

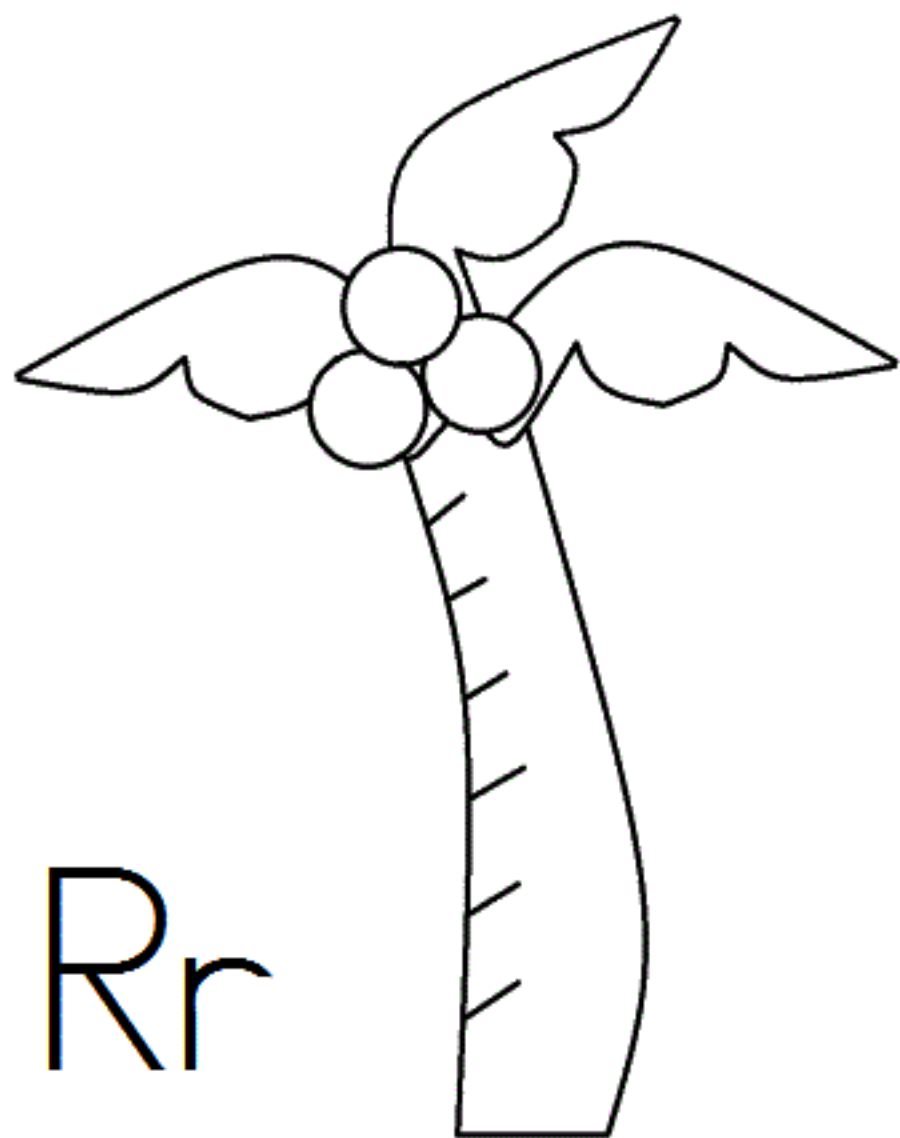

Rr

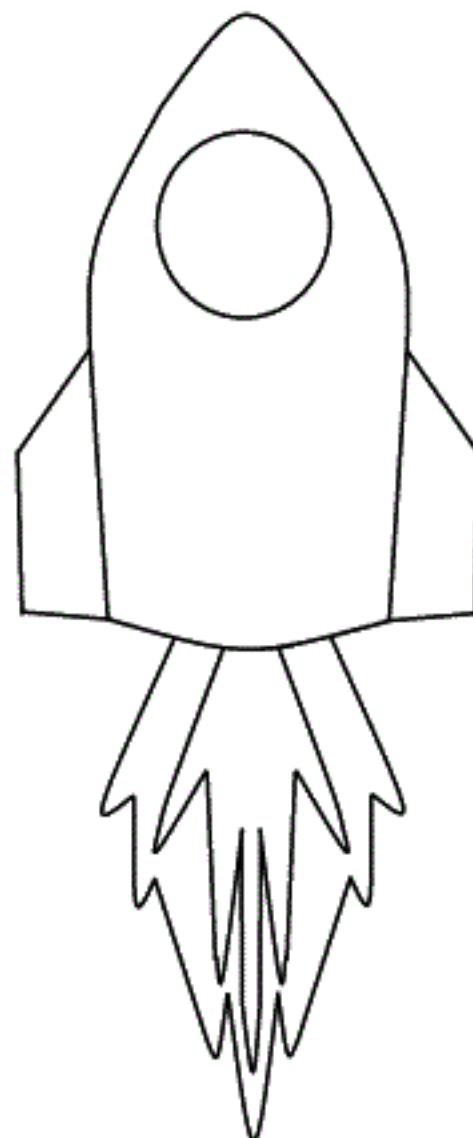



Qq

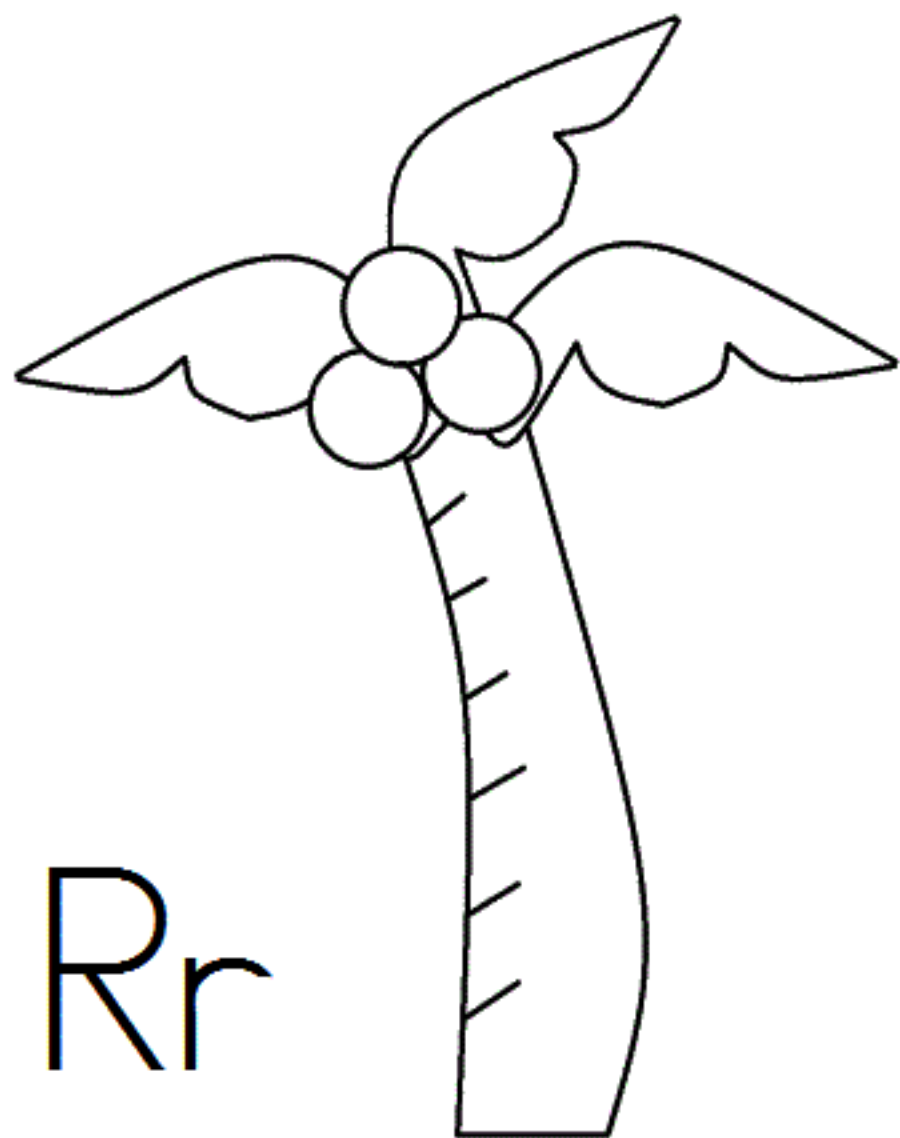

Rr

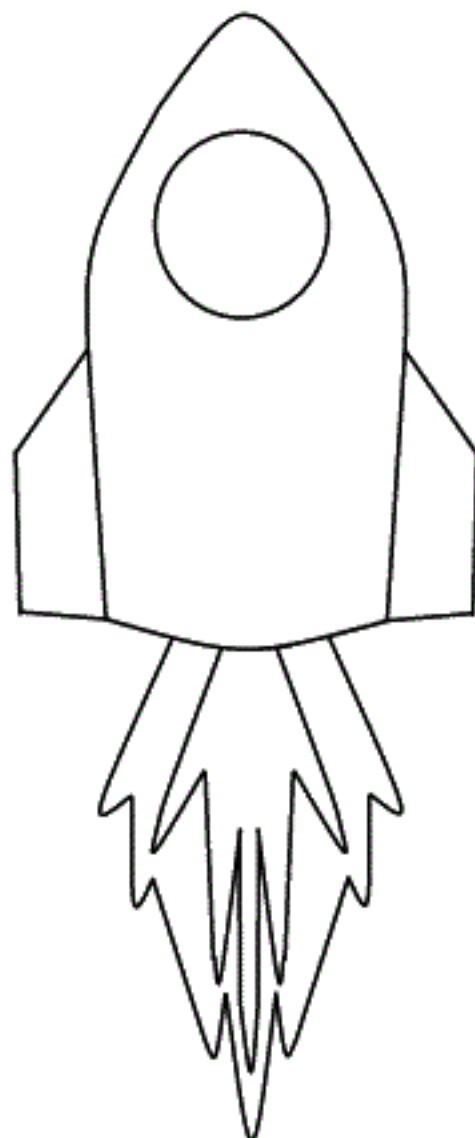

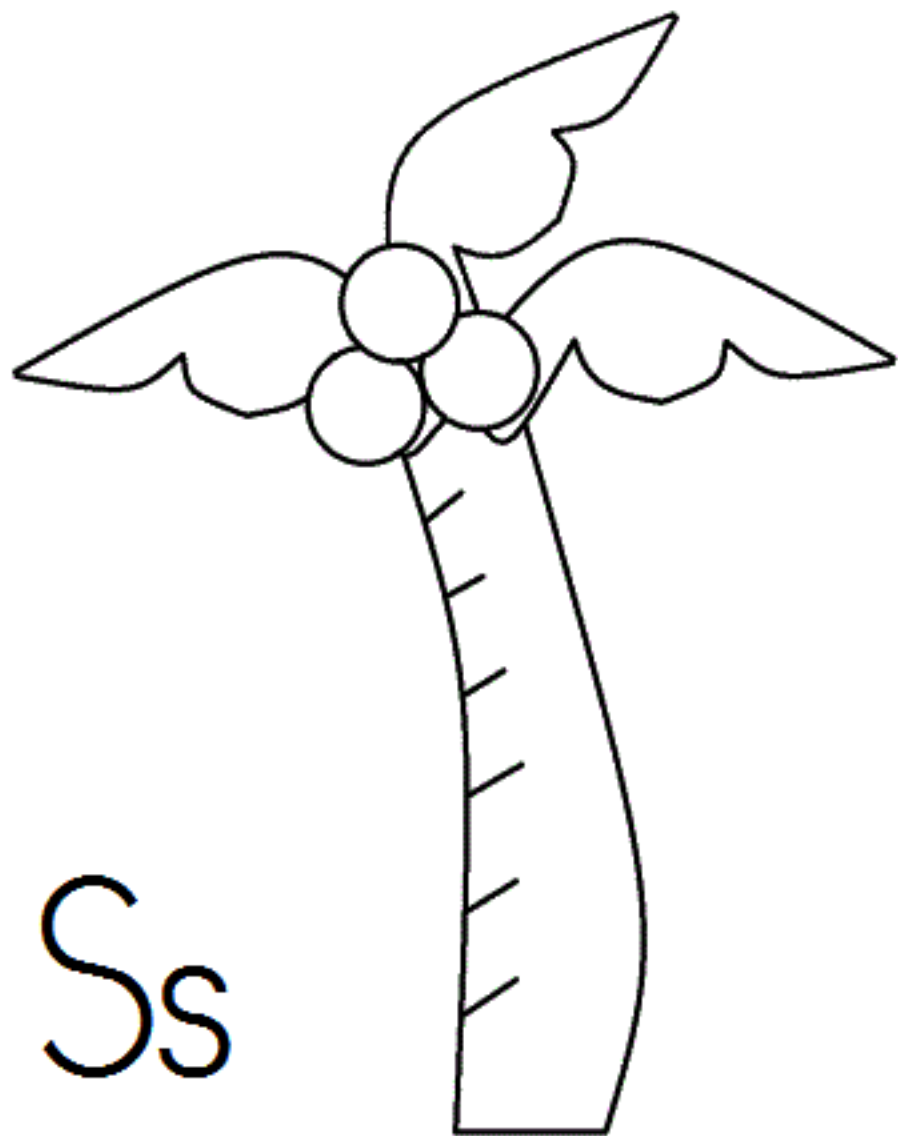

Ss

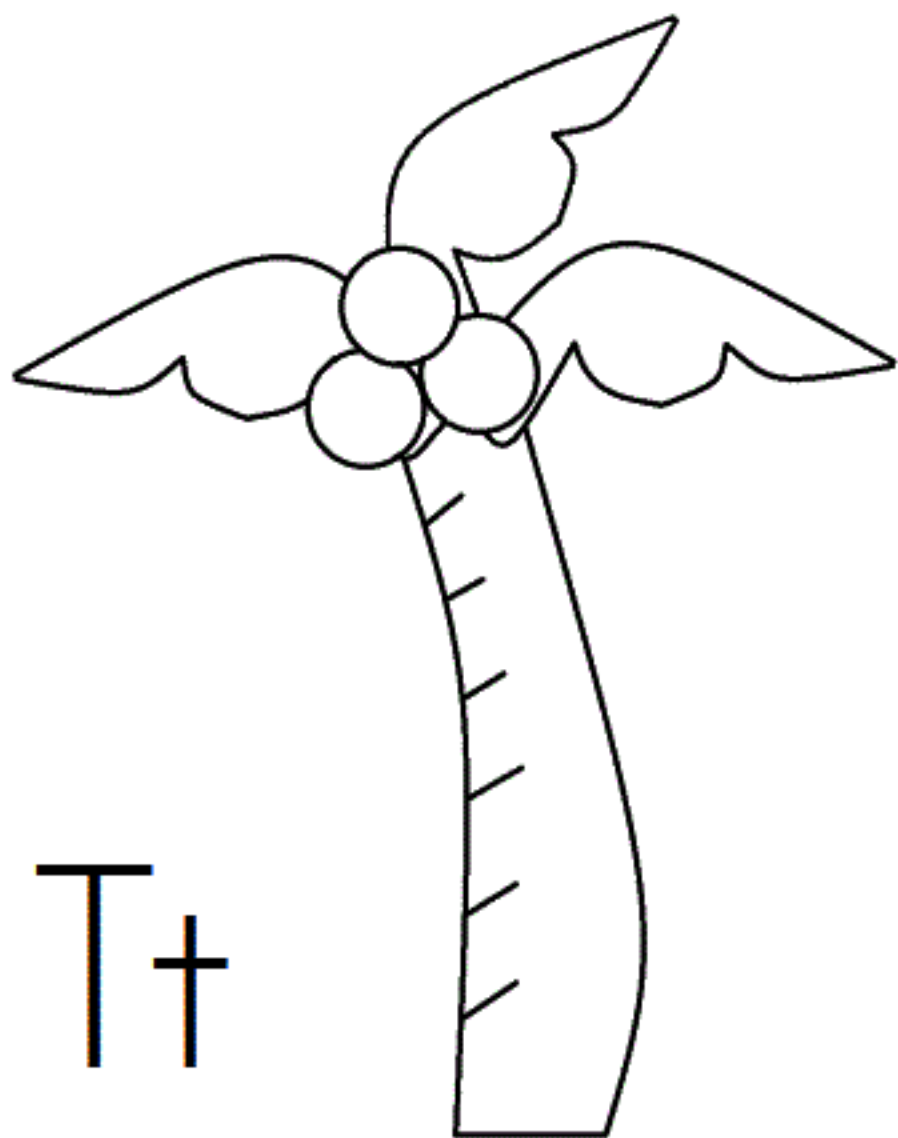

Tt

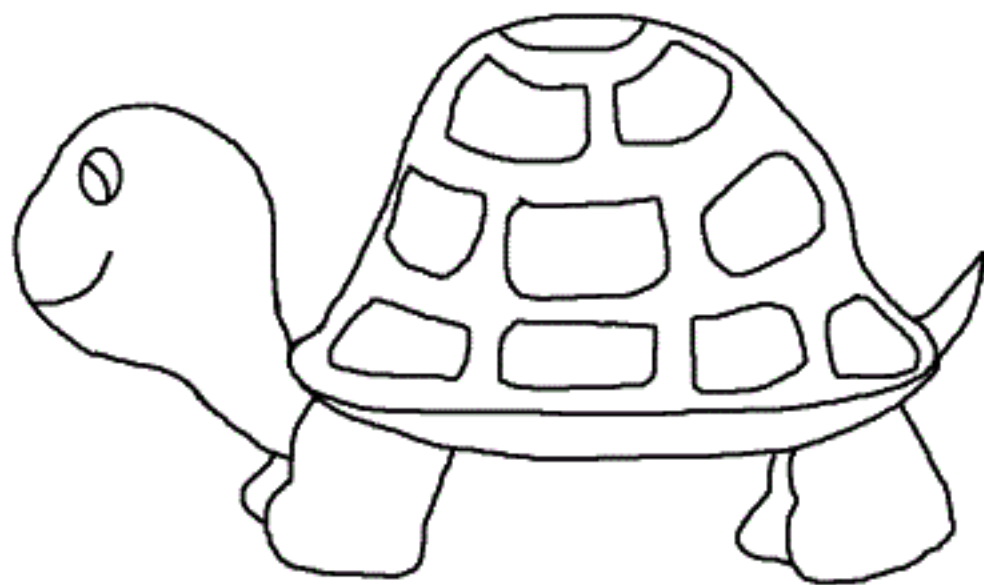

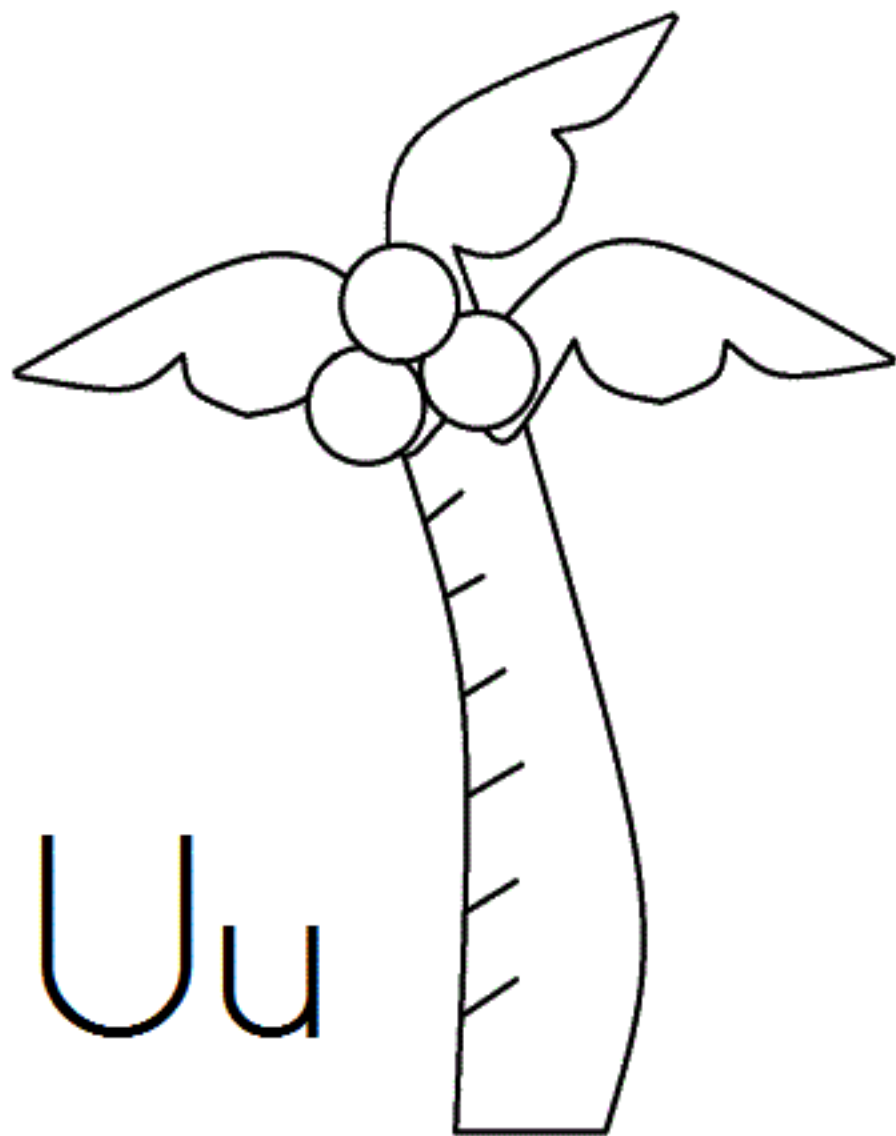

Uu

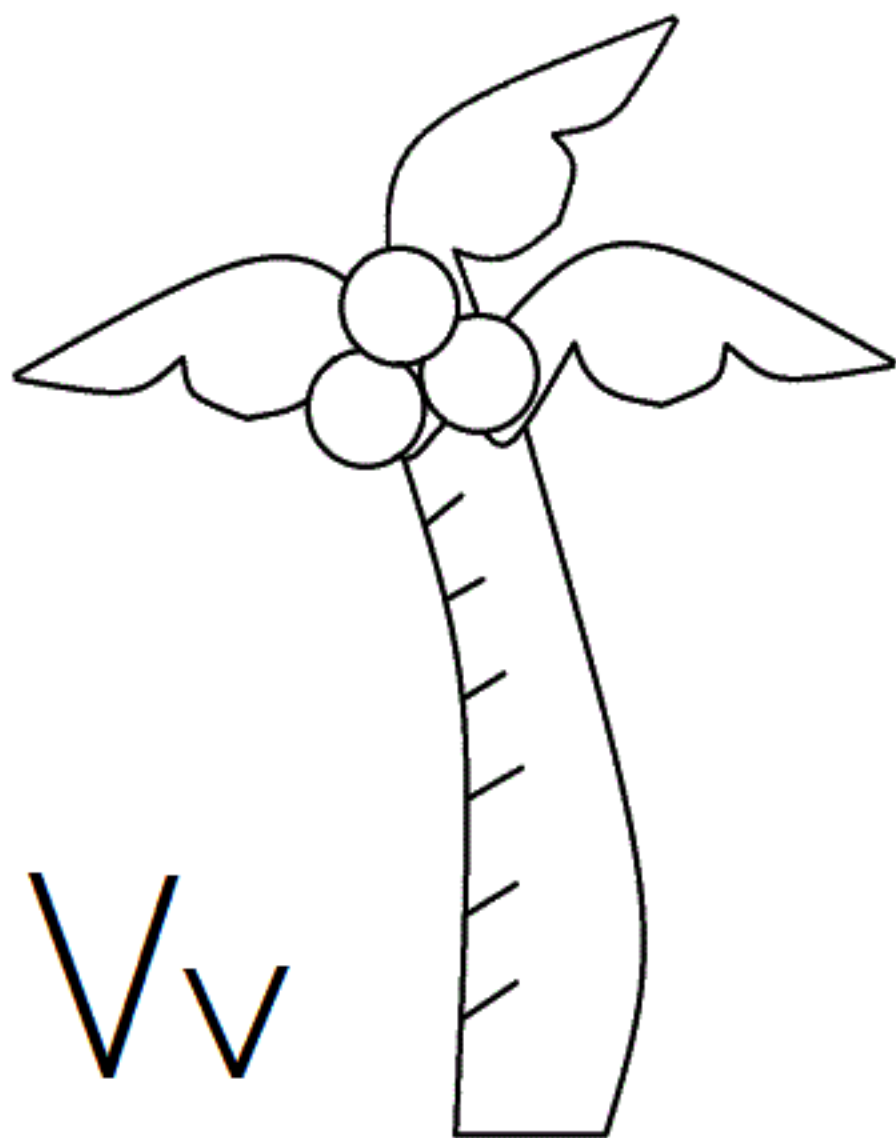
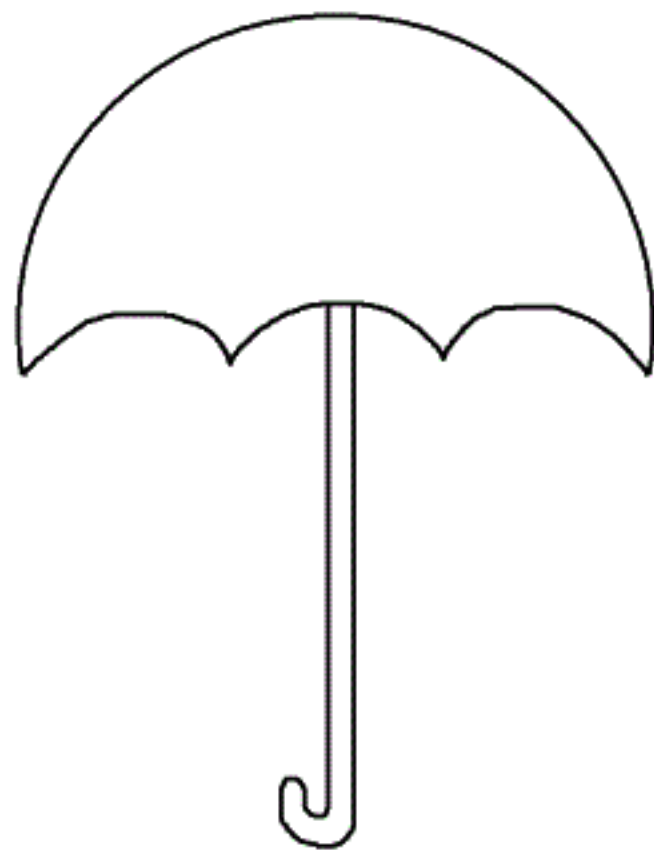

Vv



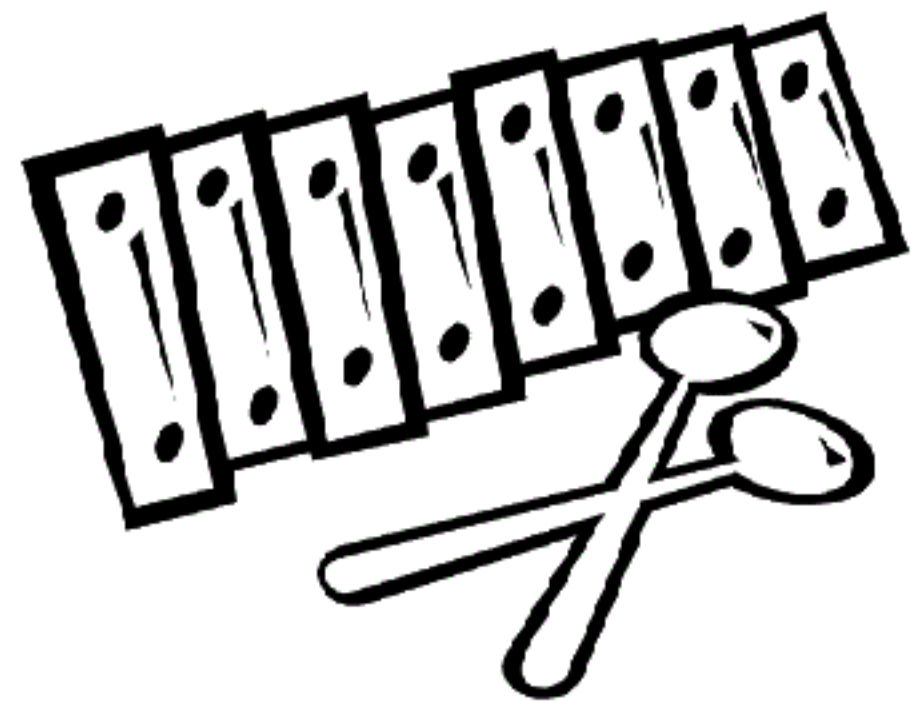
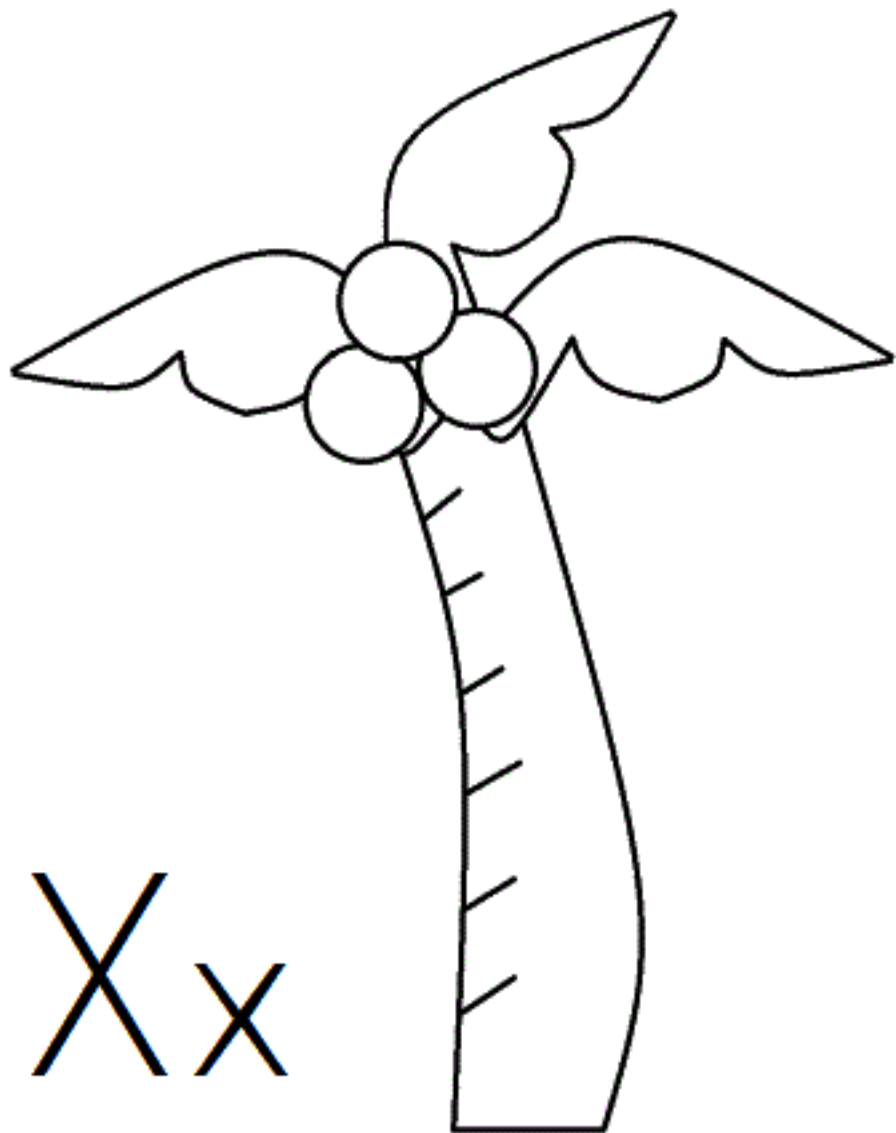
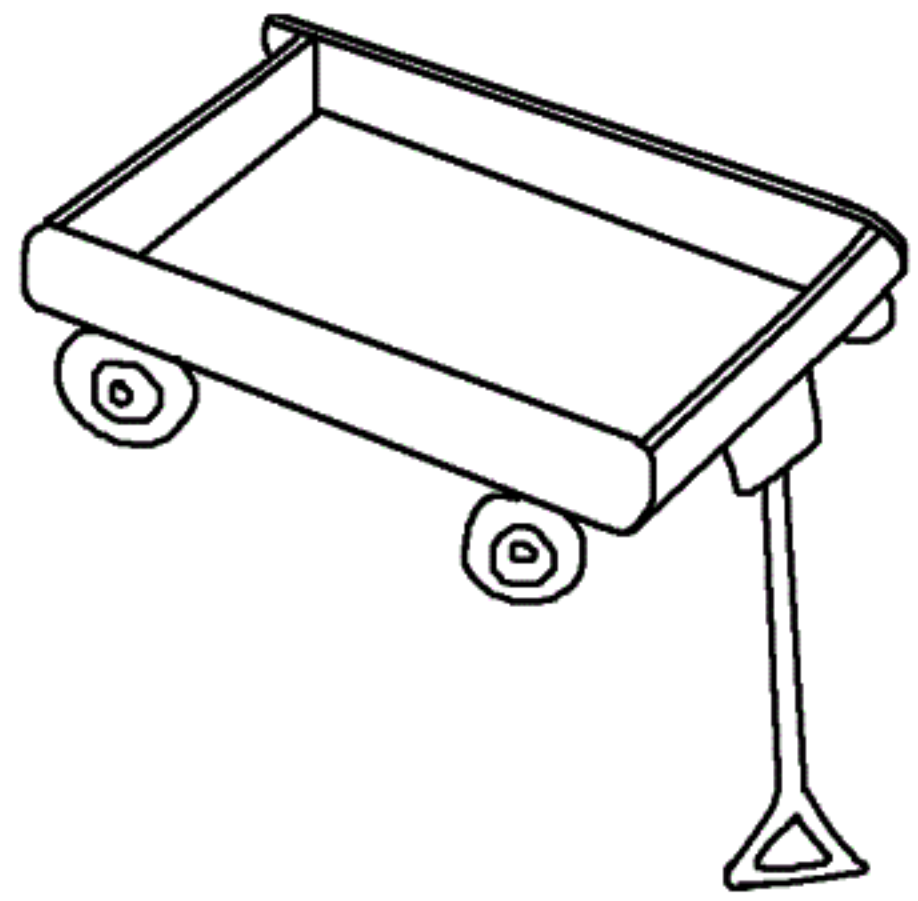
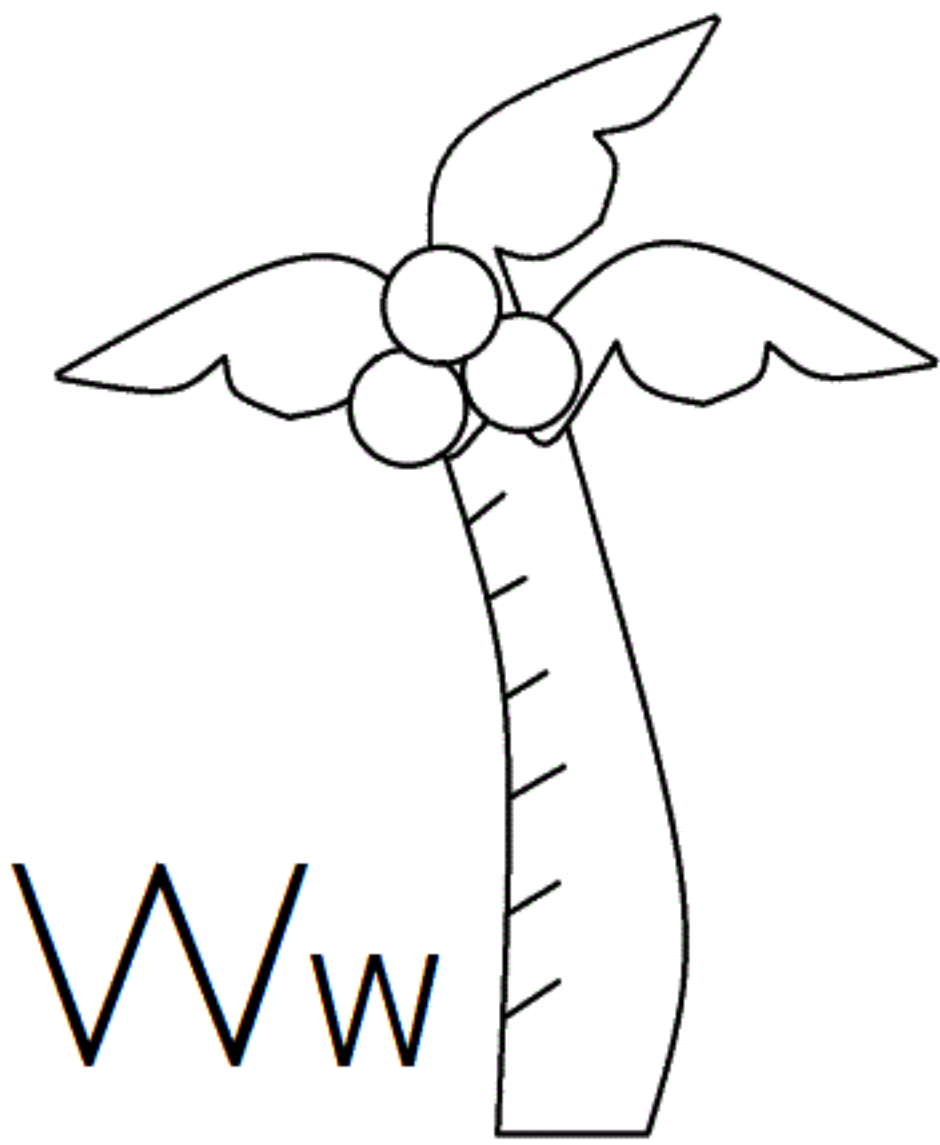

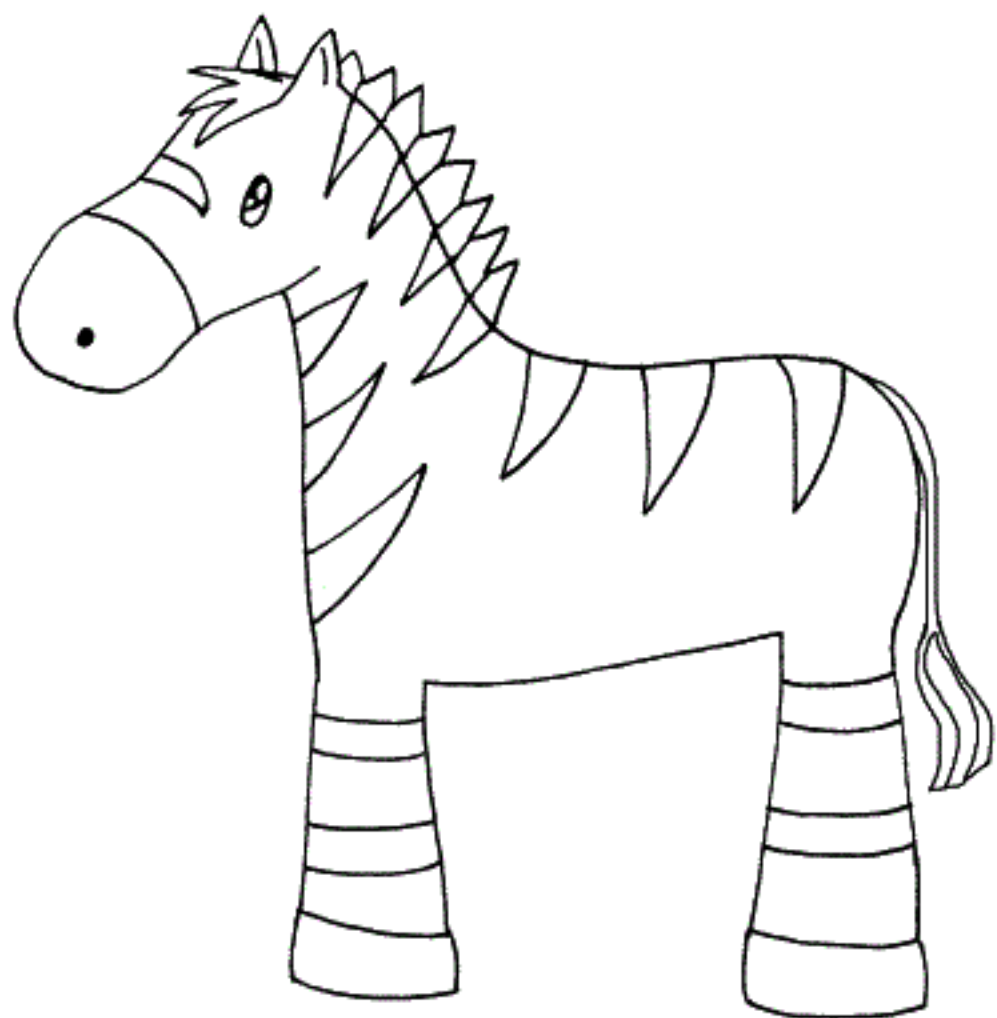
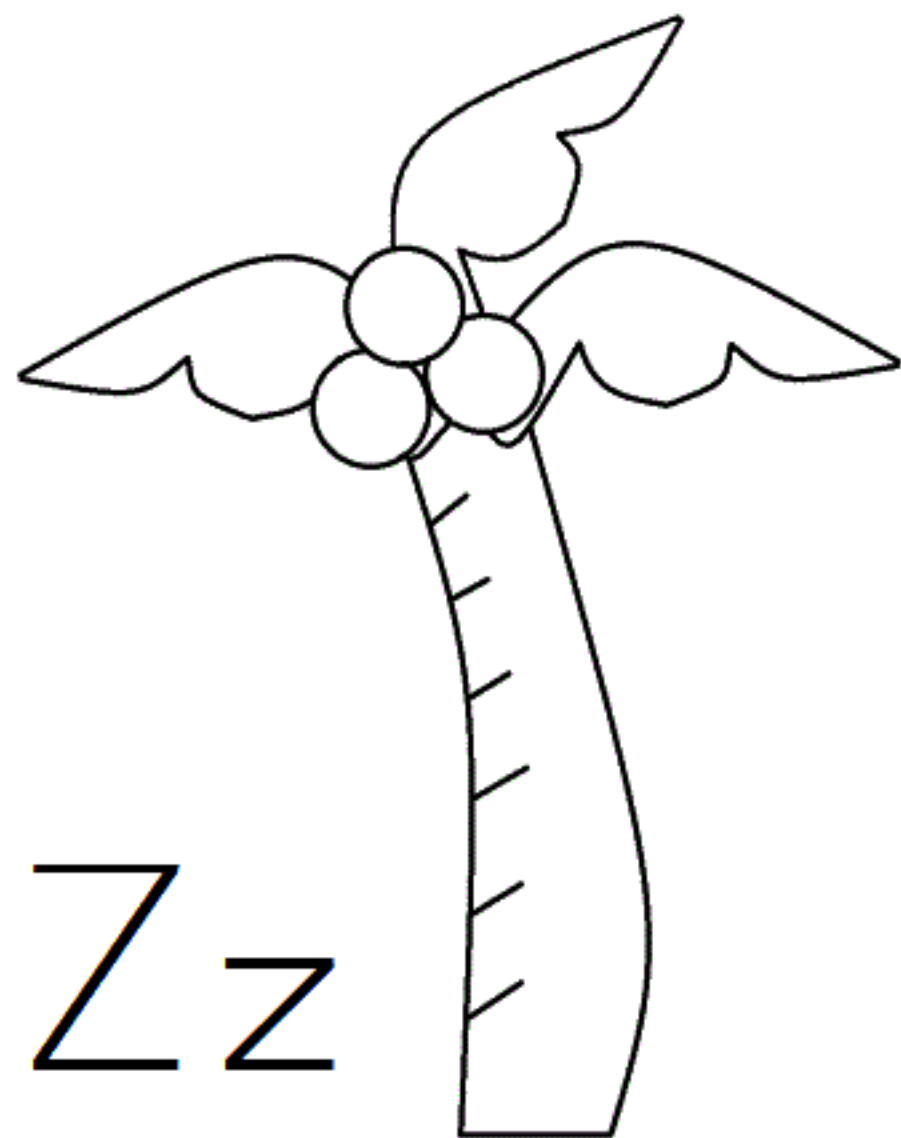
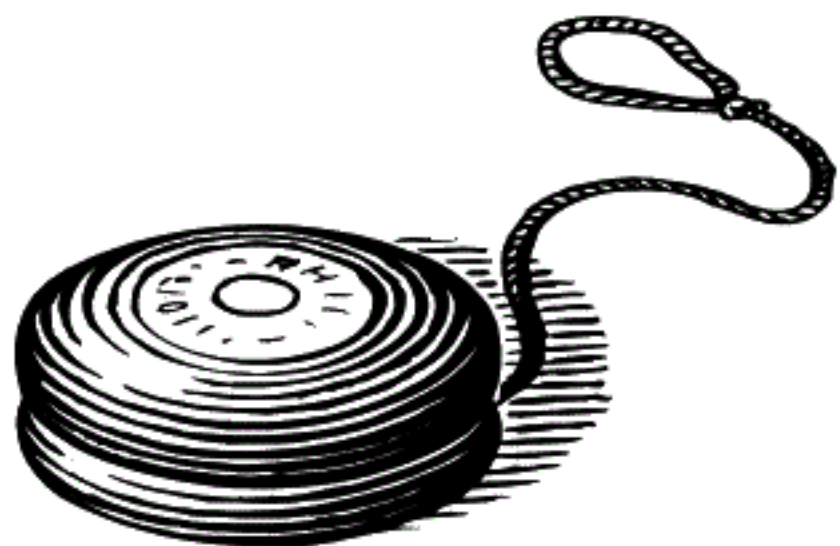
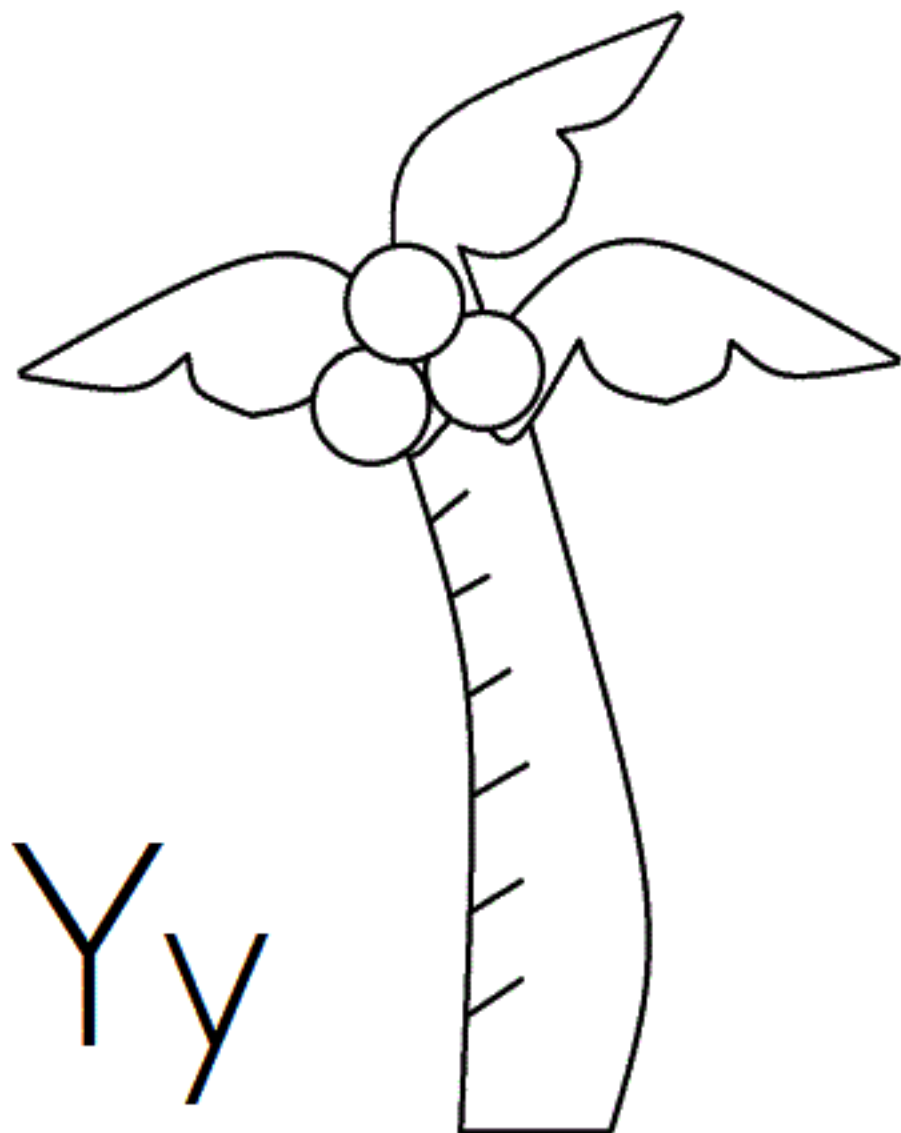

Chicka Chicka

Boom Boom

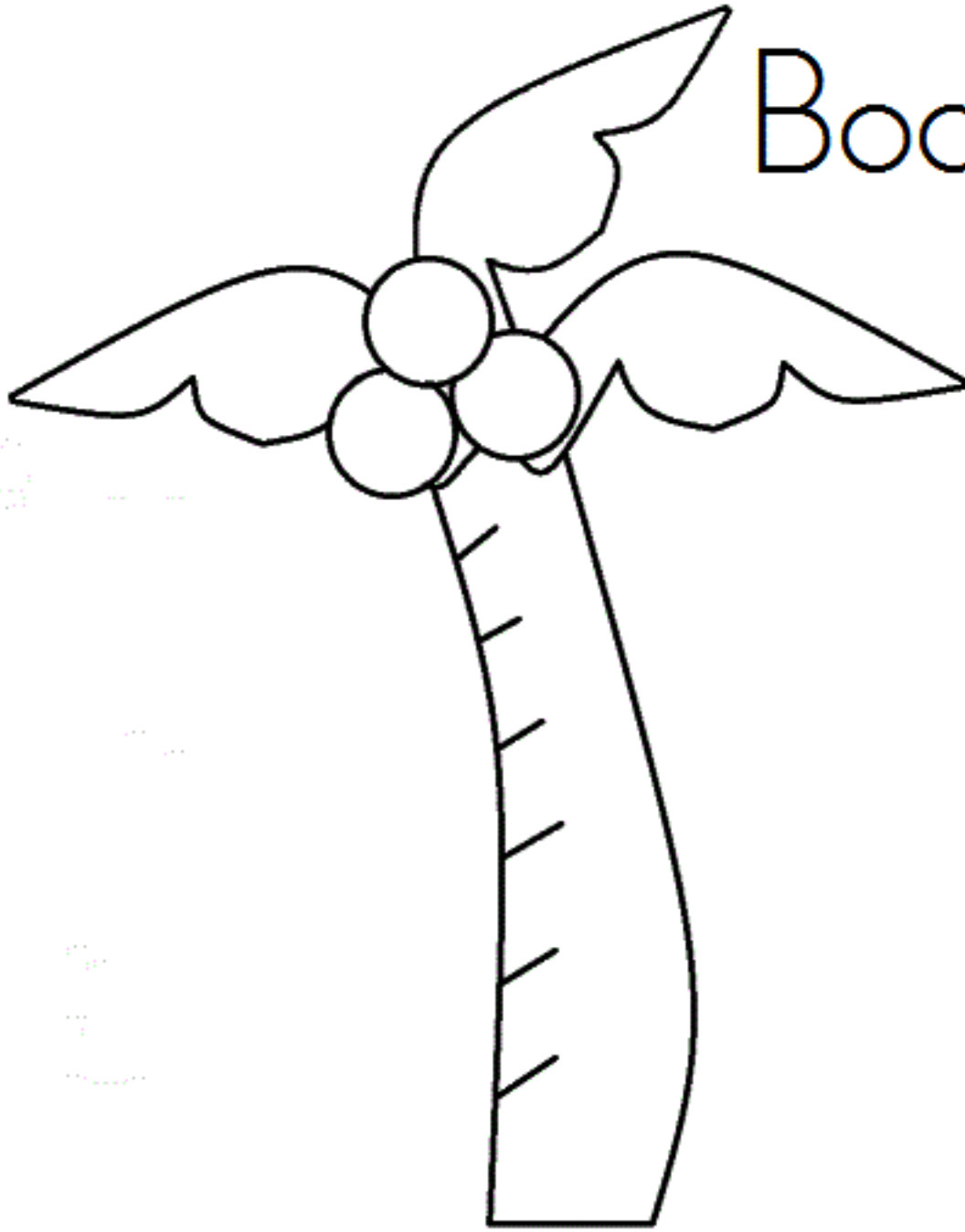

By _____

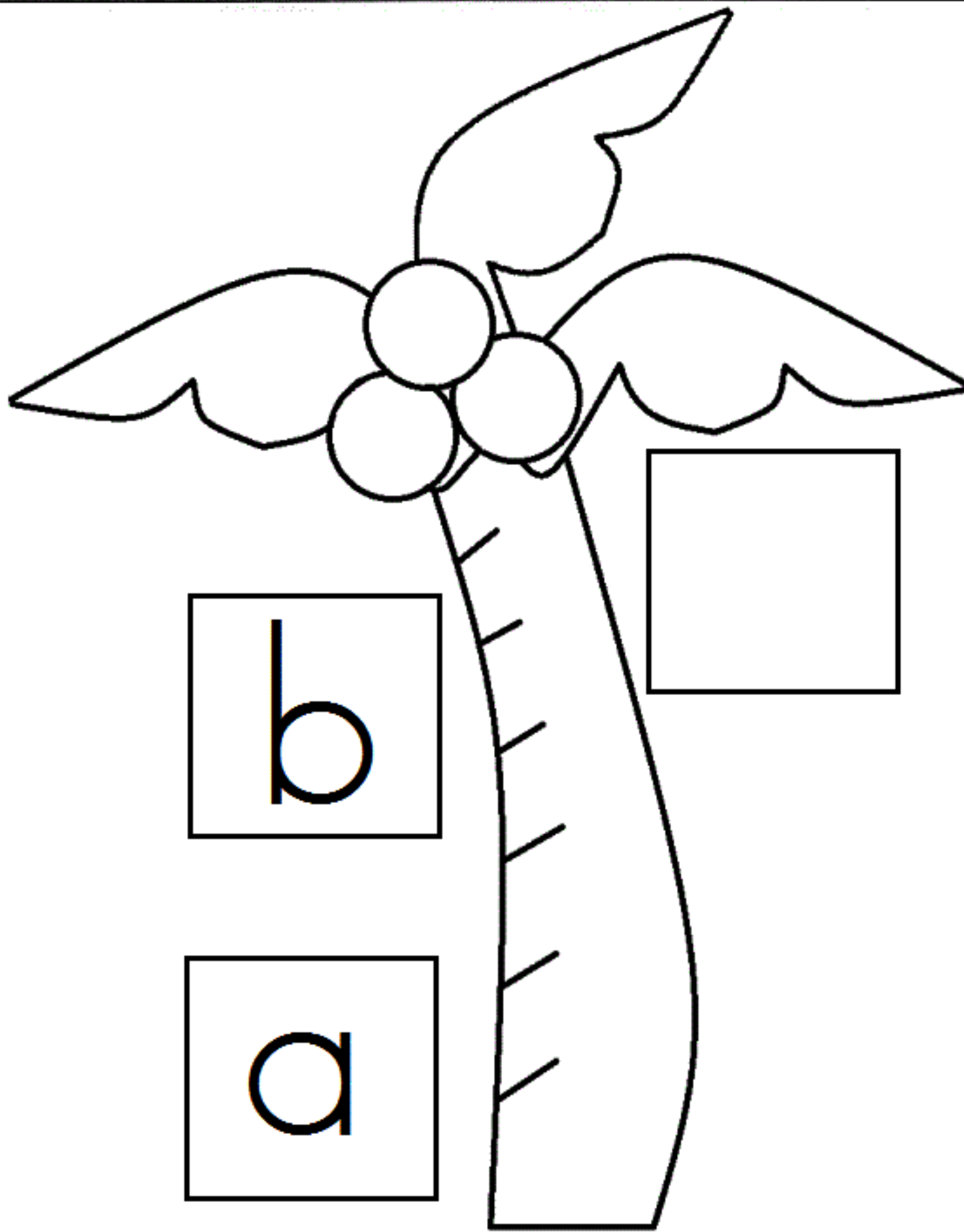

b

d

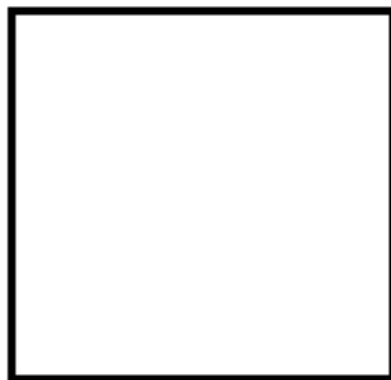

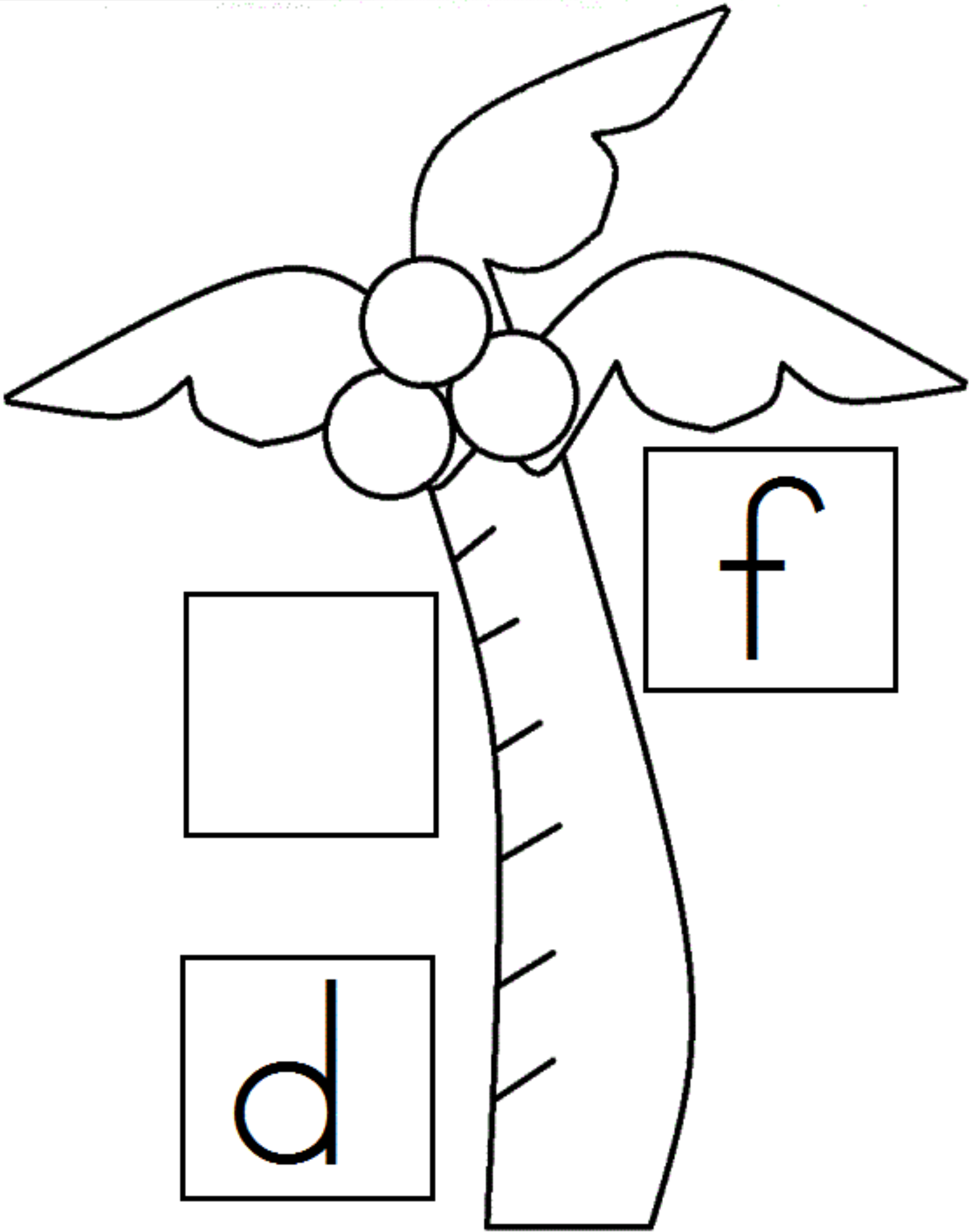

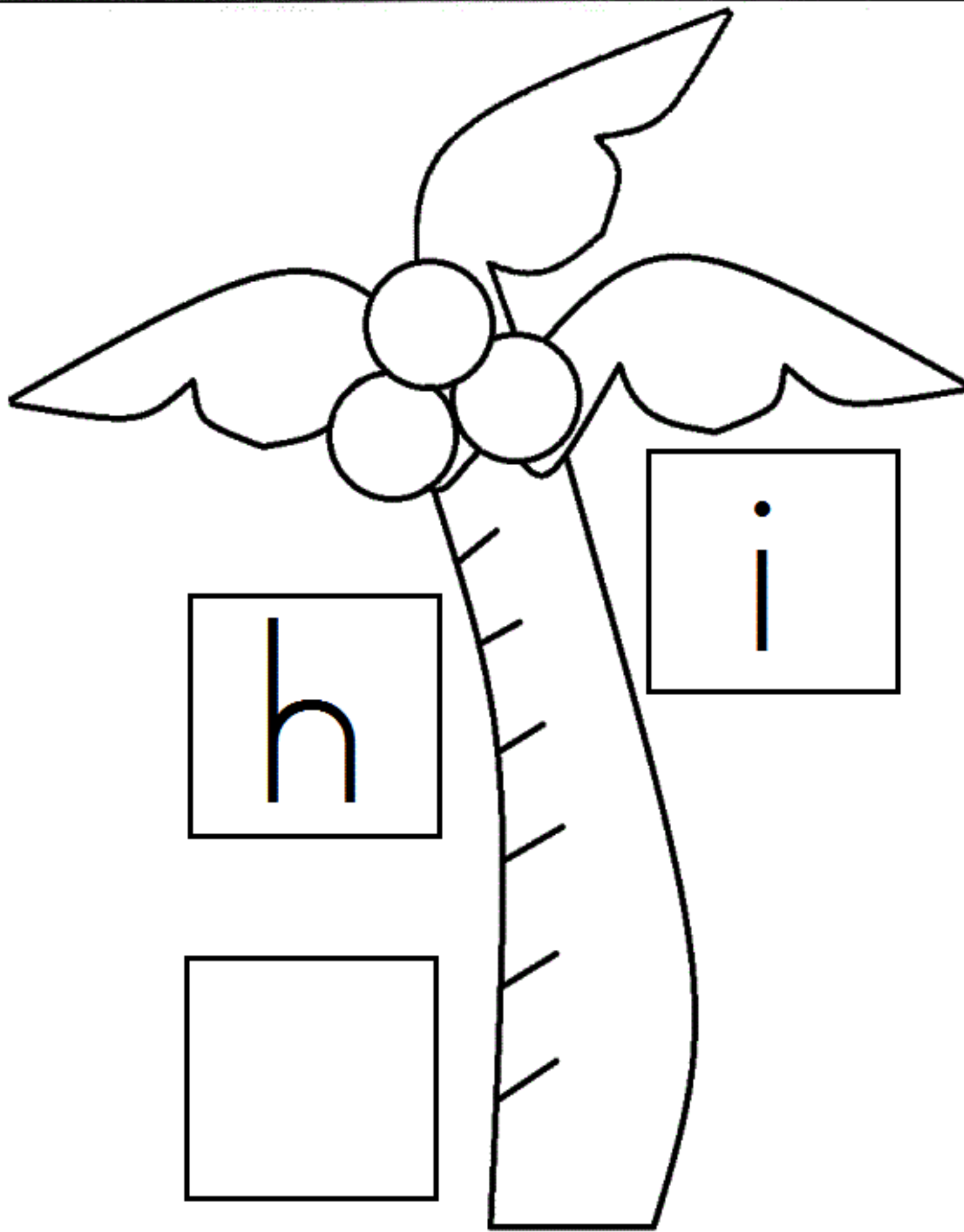

h

i

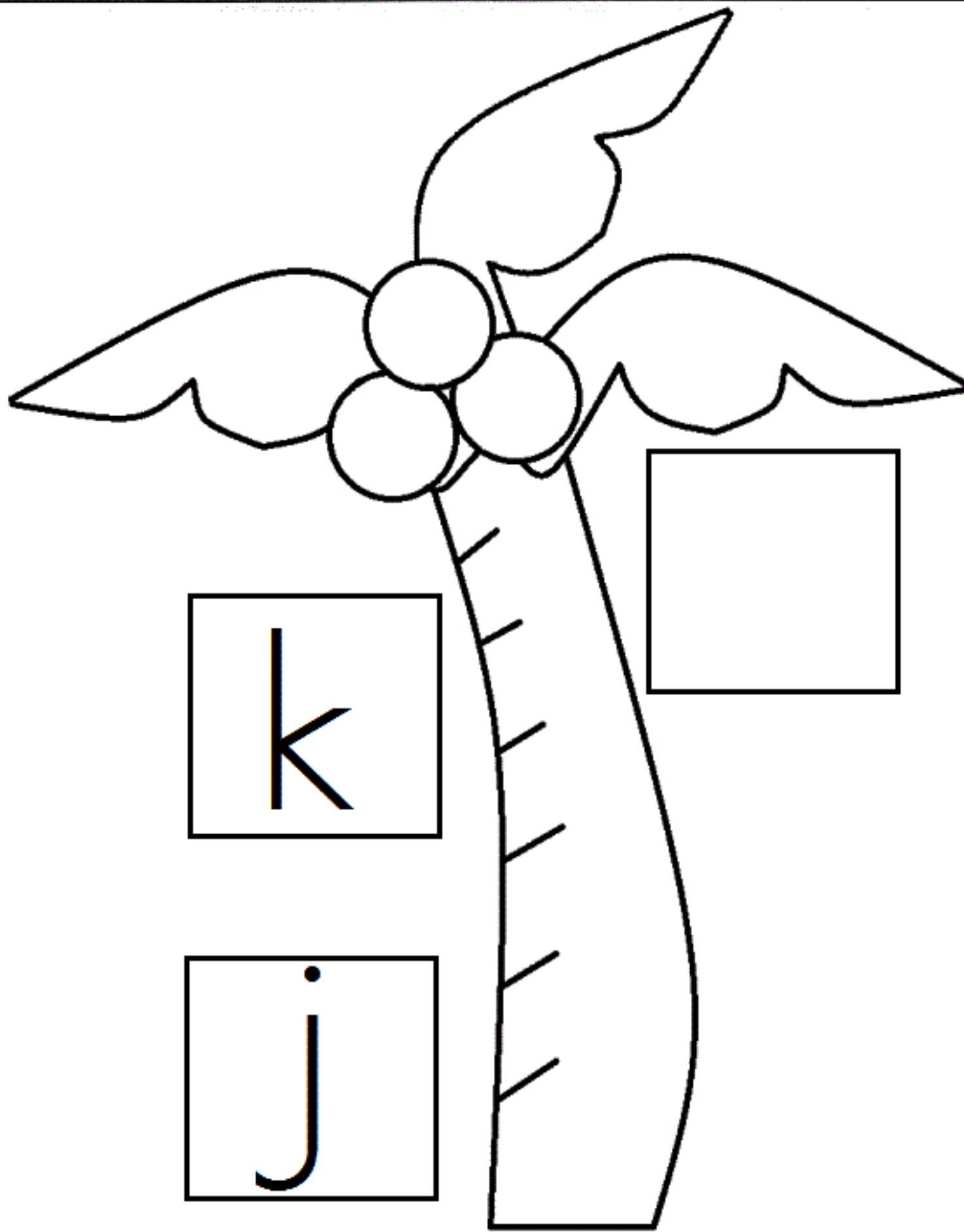

k

j



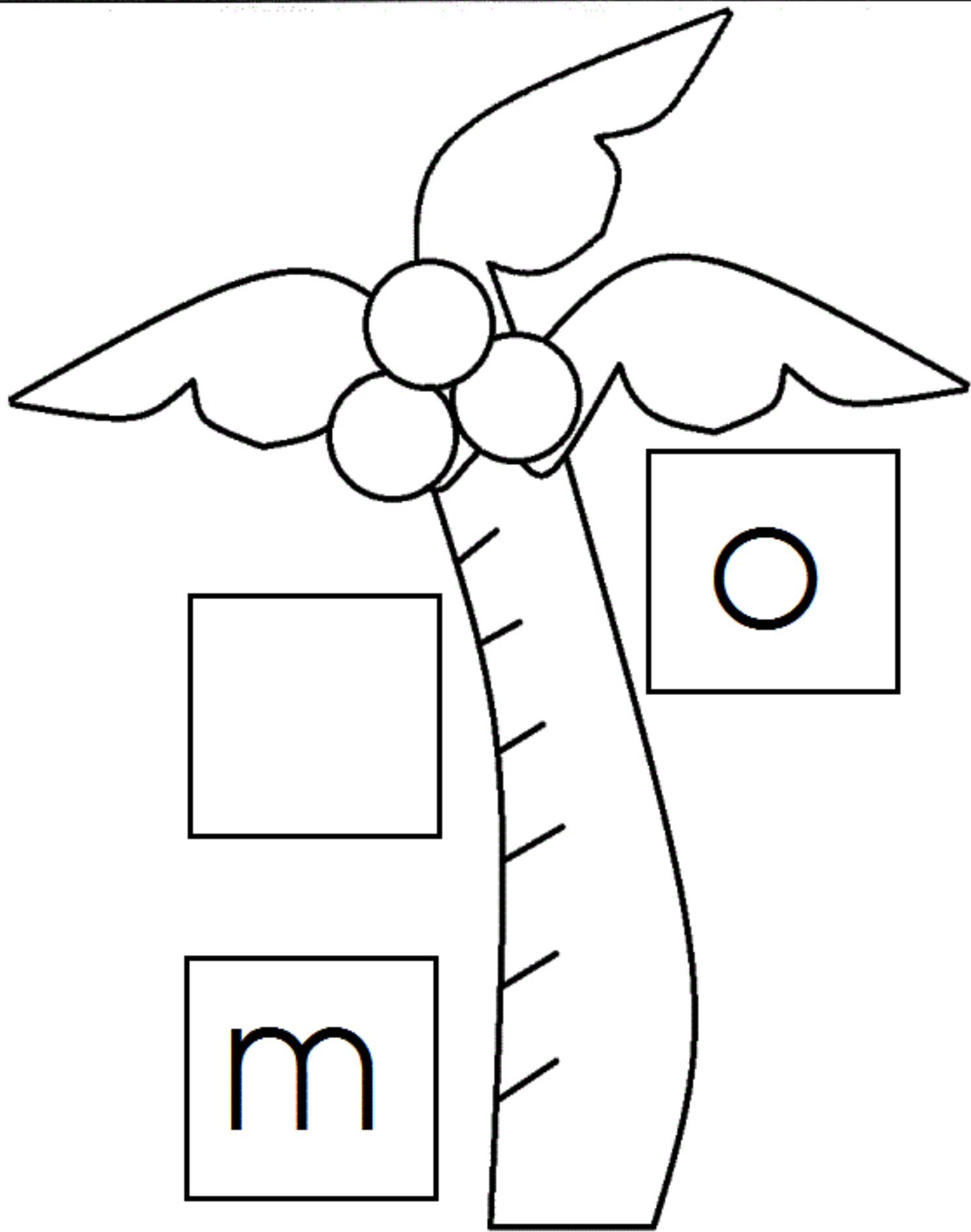

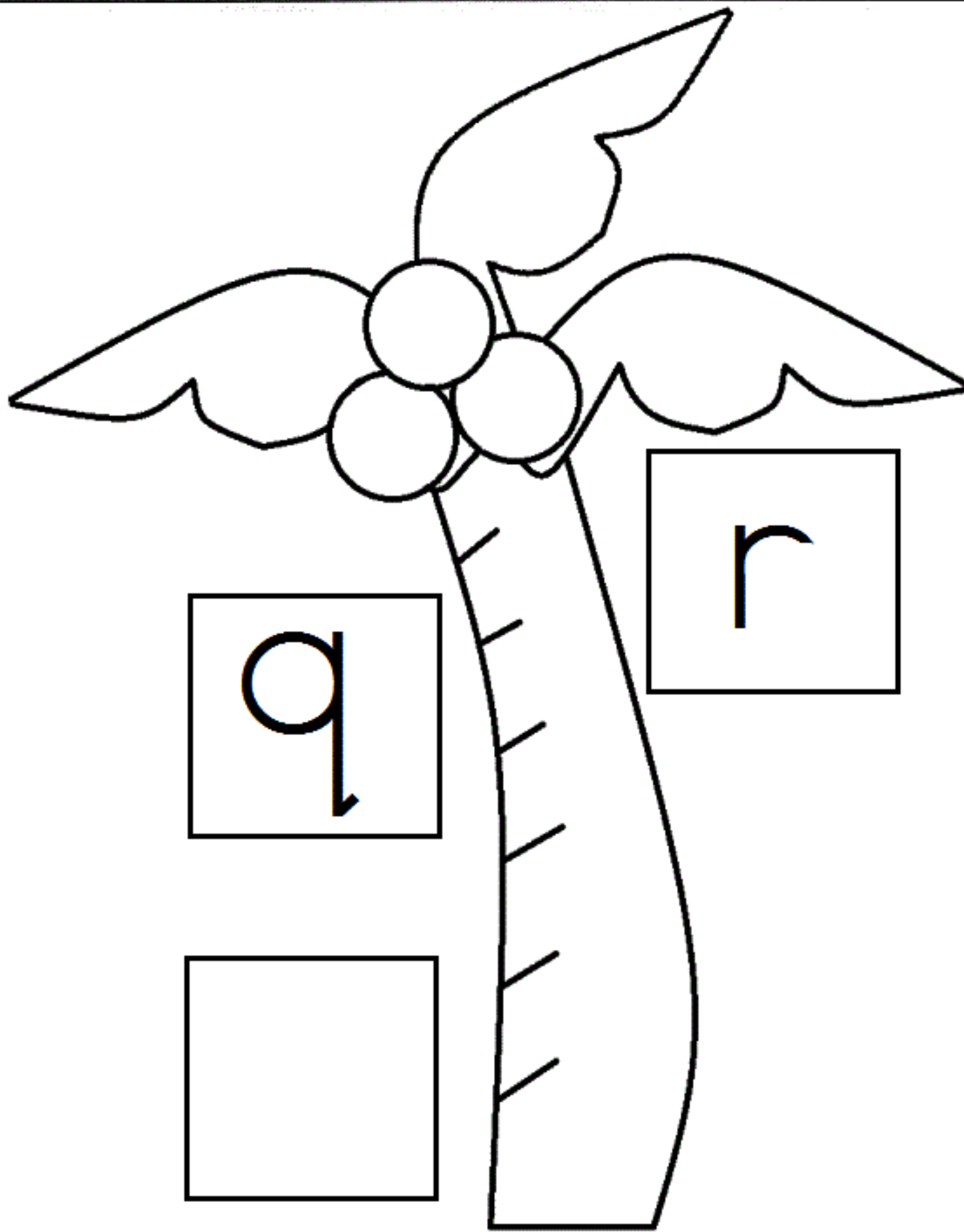

q

r

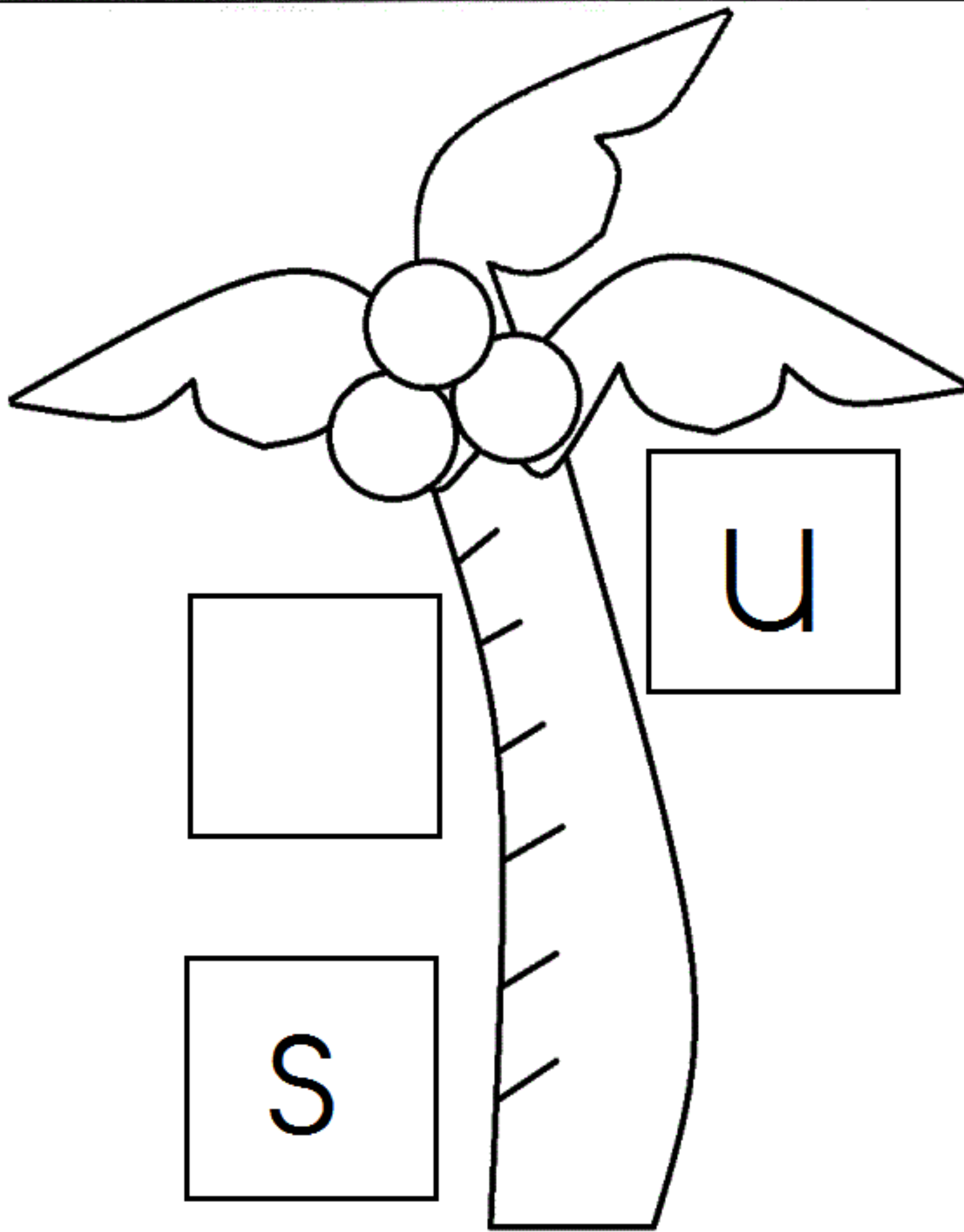

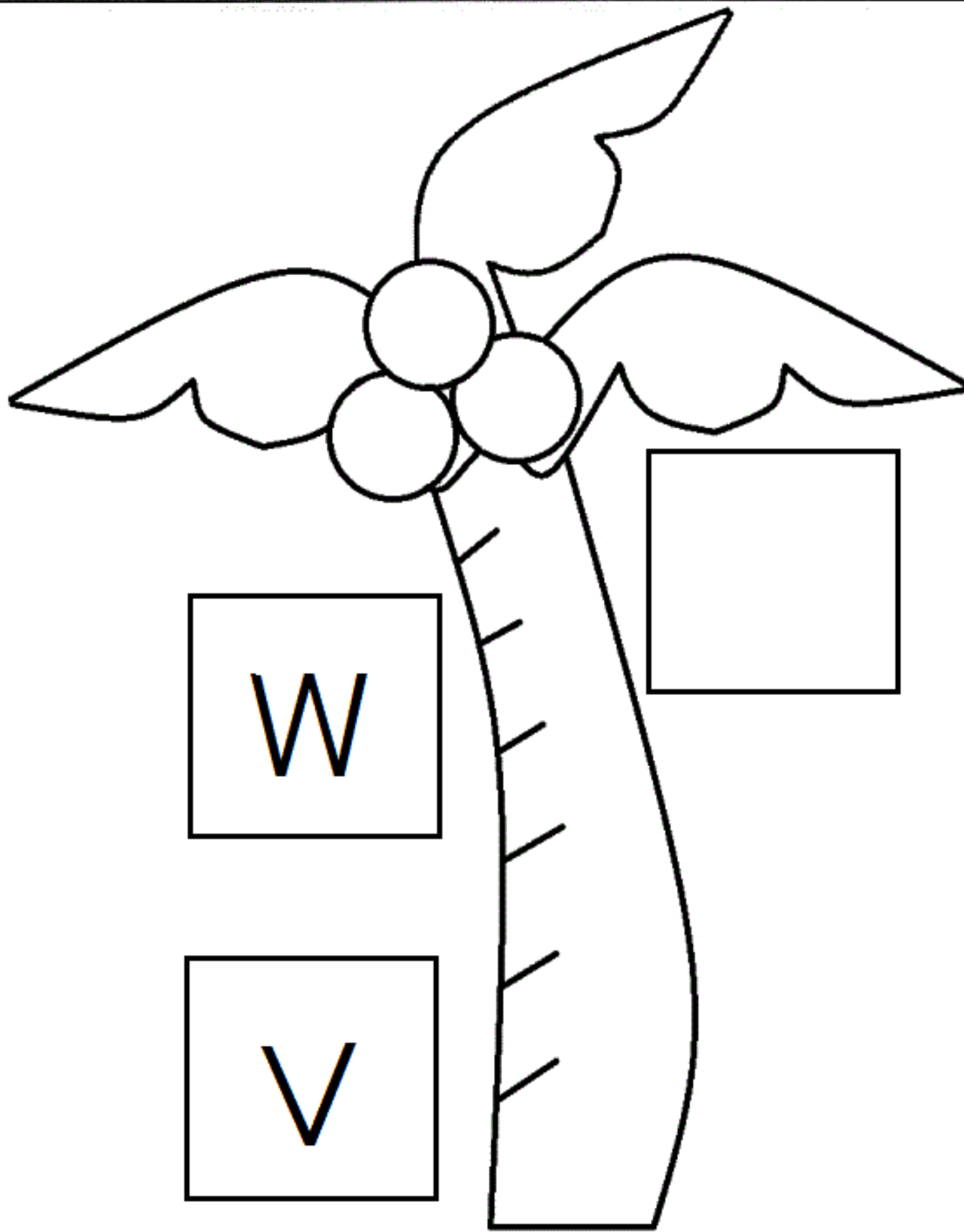

W

V

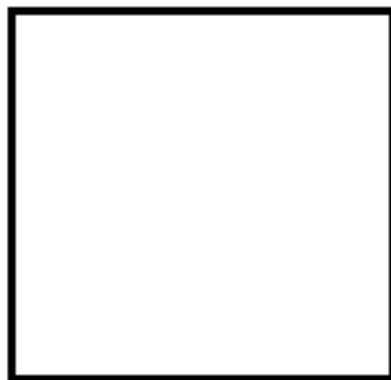

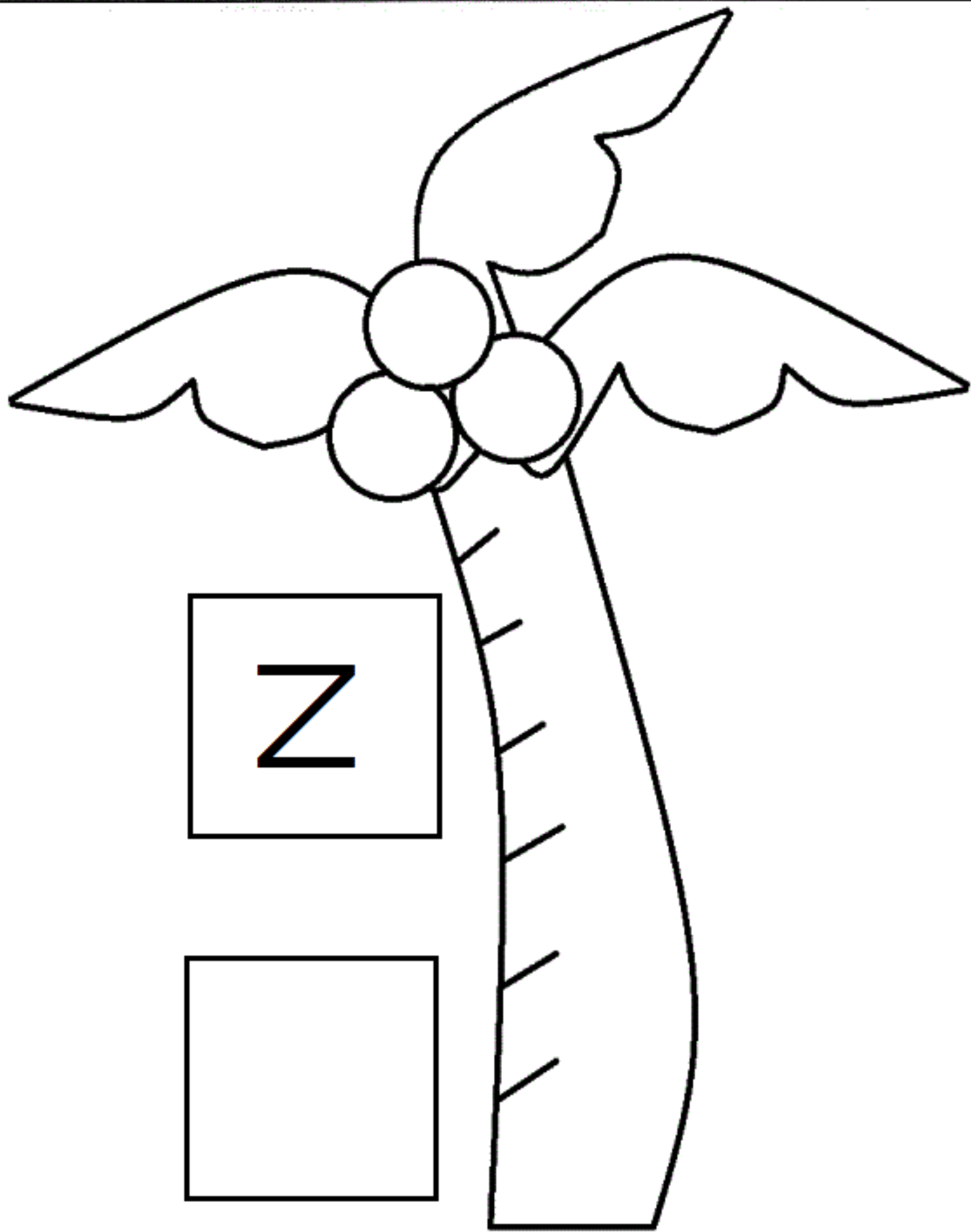

c	e	g	l
<u>n</u>	<u>p</u>	t	x
y			

Count the Coconuts

Number Puzzles



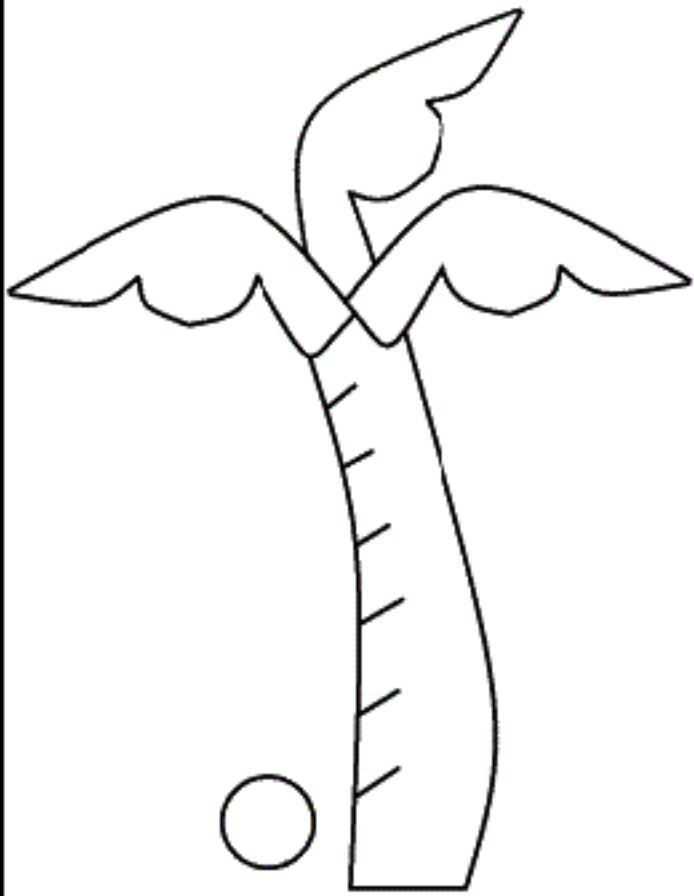

1

one

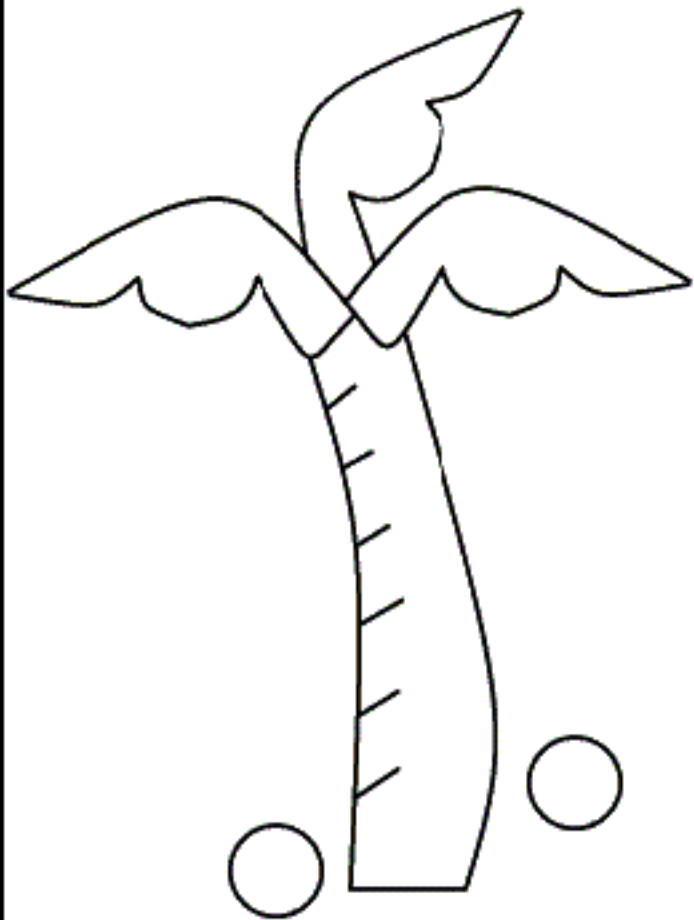

2

two

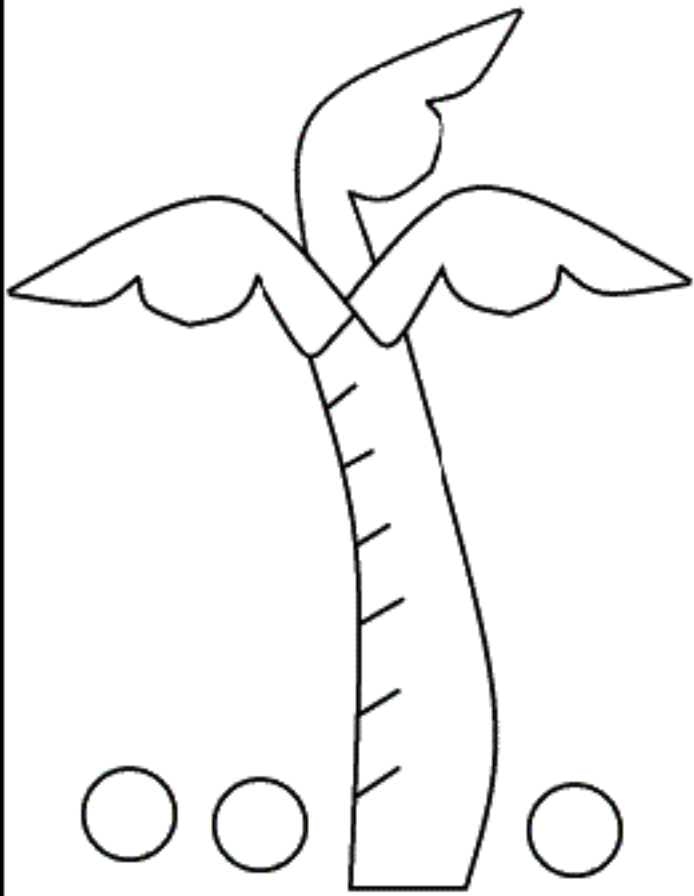

3

three

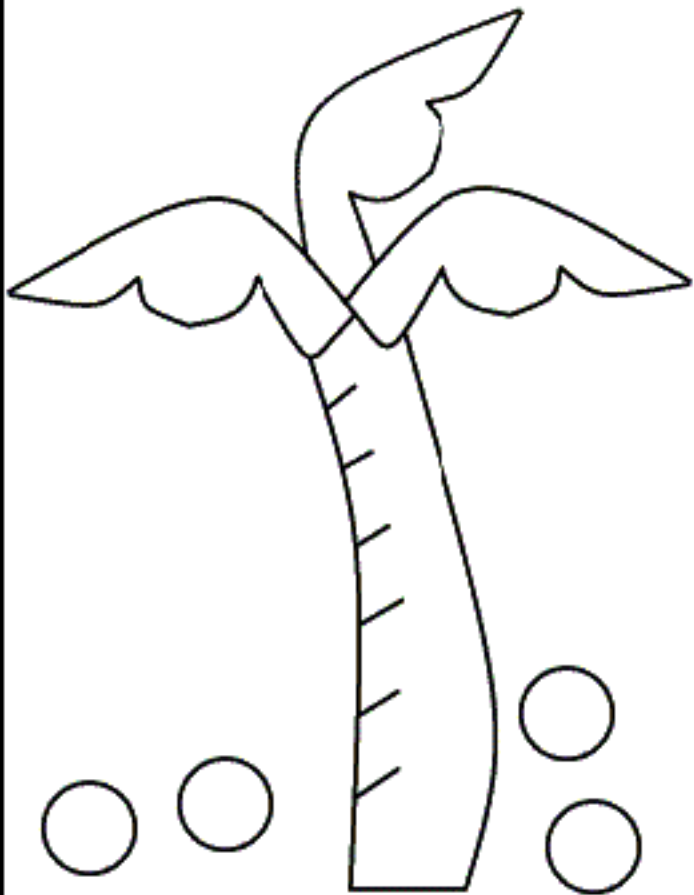

4

four

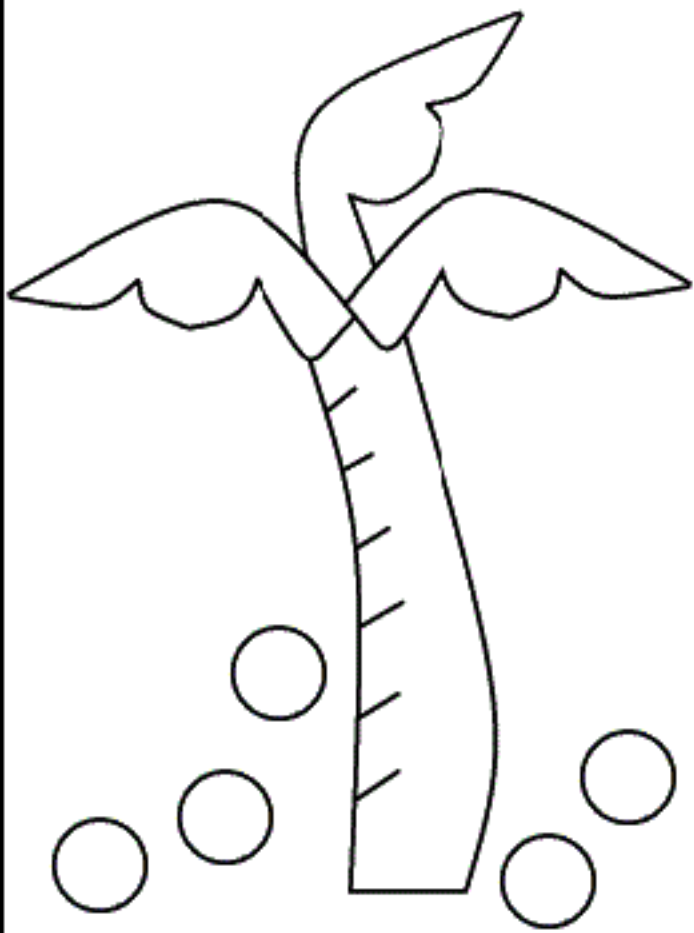

5

five

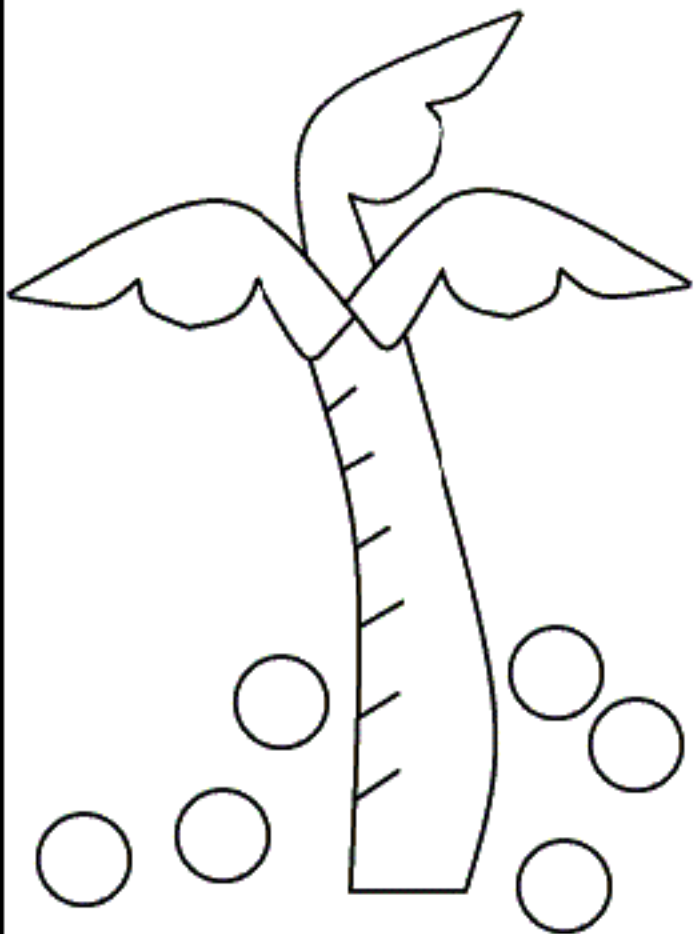

6

six

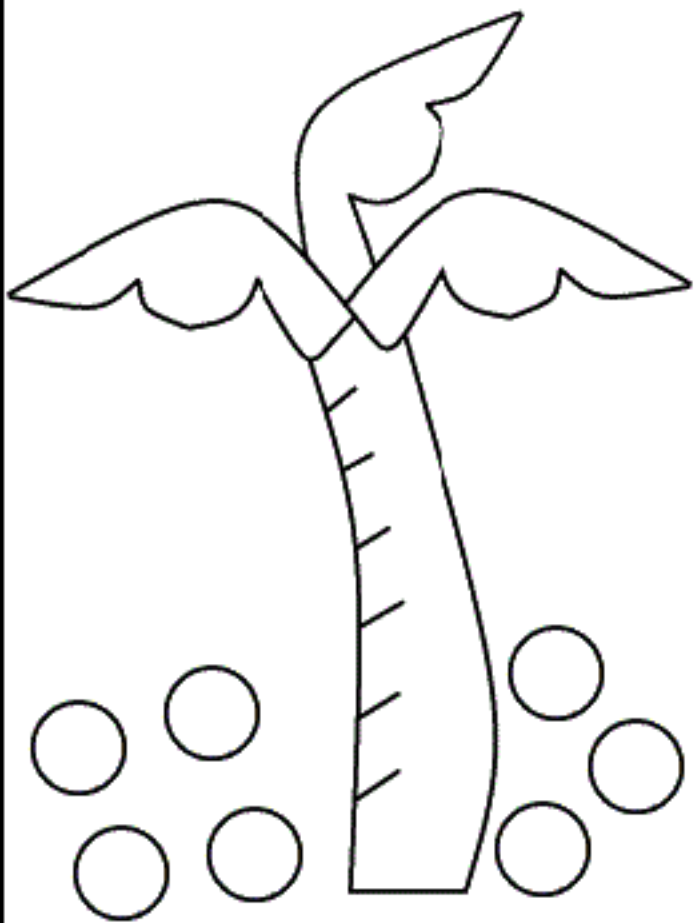

7

seven

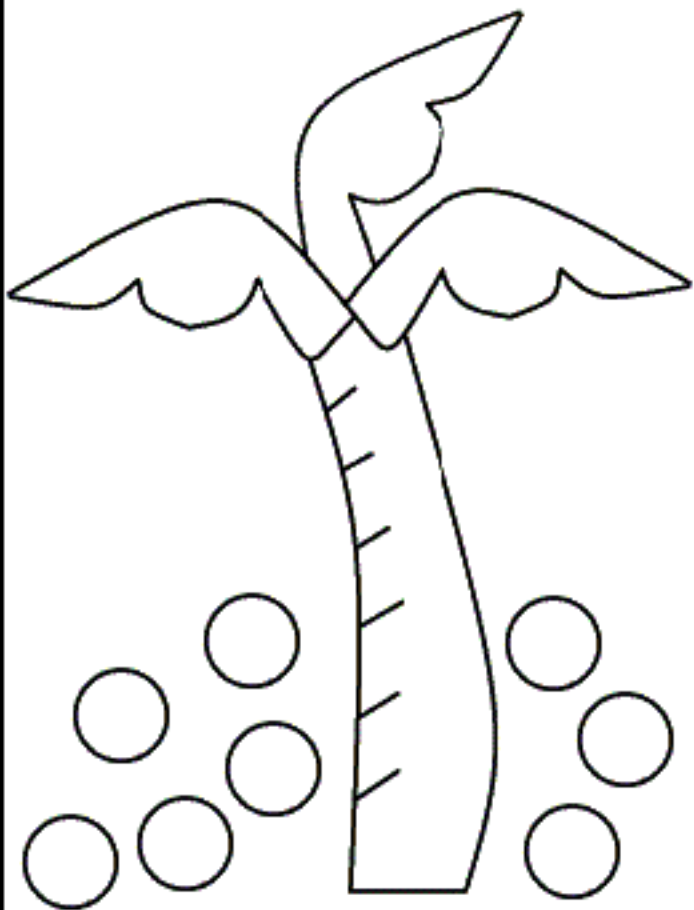

8

eight

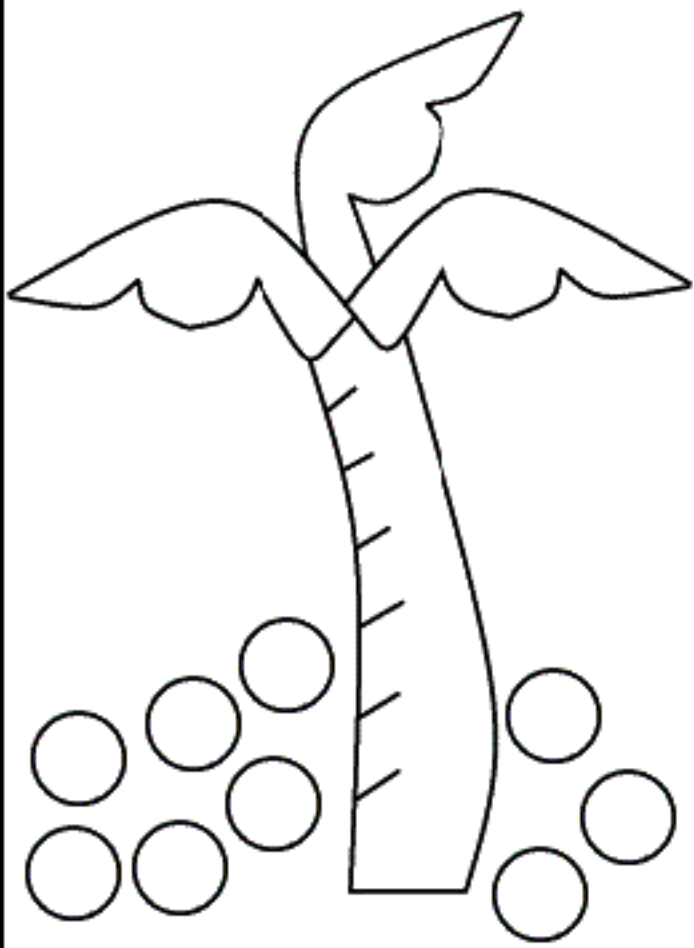

9

nine

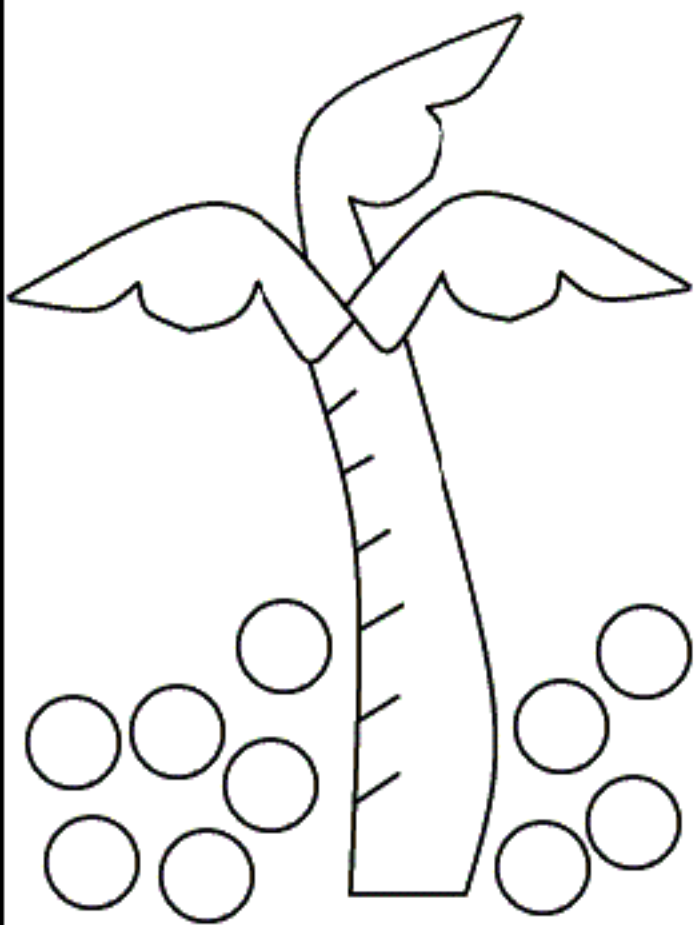

10

ten

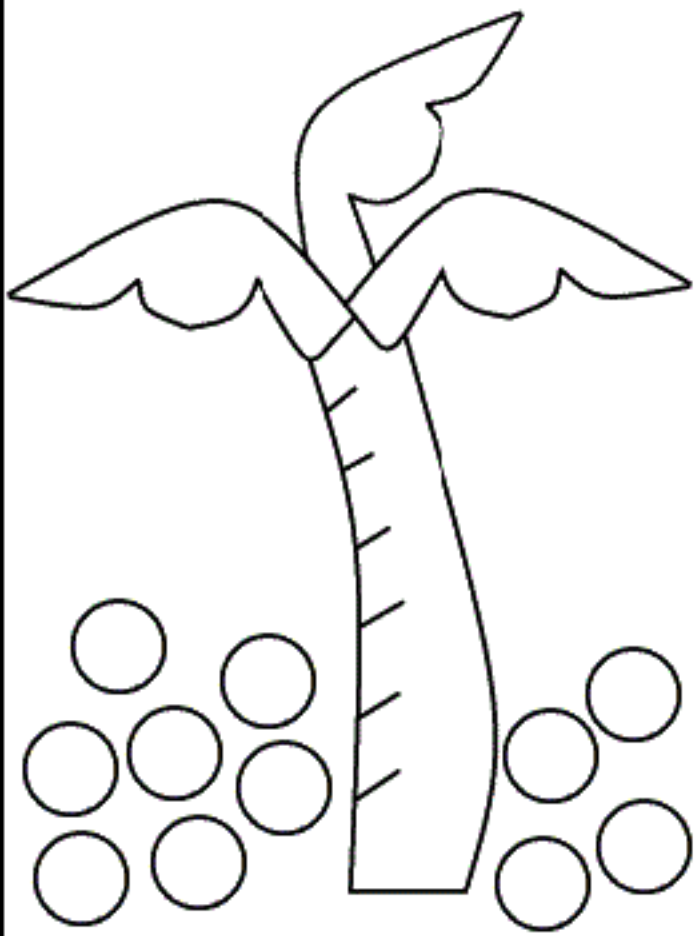

11

eleven

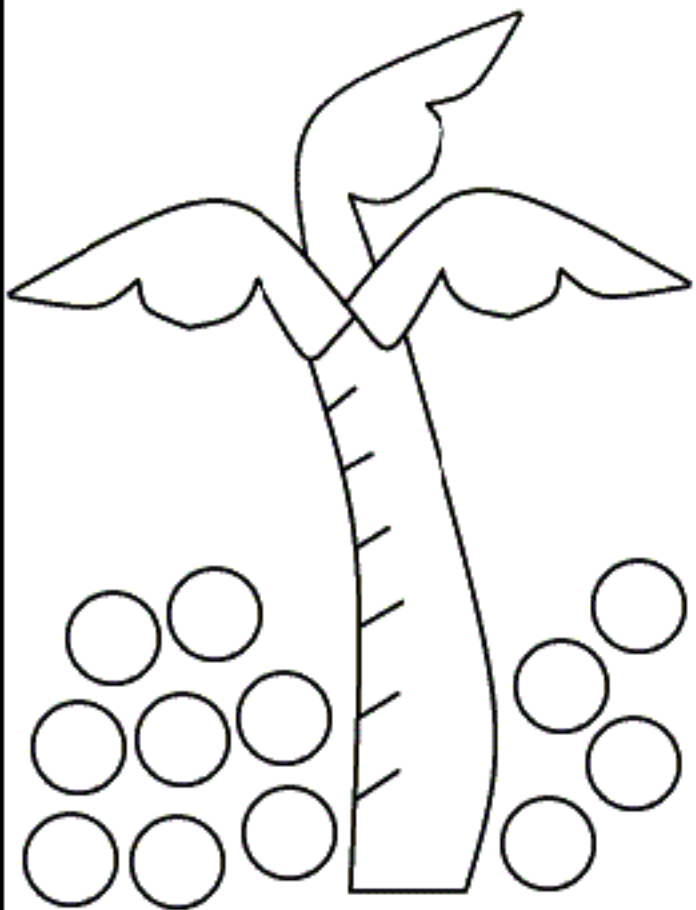

12

twelve